

INFORMATION FOR FIRST AND SECOND RESPONDERS

EMERGENCY RESPONSE GUIDE FOR VEHICLE

OUTLANDER PHEV

2021 Model year



Version:1.0

Introduction

This manual provides safety instructions that need to be followed when rescuing the passengers from the vehicle after an accident and describes how to handle the damaged vehicle.

Failure to follow these instructions and especially the warnings and cautions may result in serious injury such as an electrical shock due to the high voltage battery installed on OUTLANDER PHEV.

Please read and understand this manual carefully for your and the passengers safety.

Throughout this manual the words **WARNING**, **CAUTION** appear. These serve as reminders to be especially careful. Failure to follow instructions could result in personal injury or damage to your vehicle.



WARNING

Indicates a strong possibility of severe personal injury or death if instructions are not followed.



CAUTION

Means hazards or unsafe practices that could cause minor personal injury or damage to the vehicle.



NOTE

Gives helpful information.

*: indicates optional equipment.

It may differ according to the sales classification; refer to the sales catalogue.

Mitsubishi Motors reserves the right to make changes in design and specification and/or to make additions to or improvements in this product without obligation to install them on products previously manufactured.

- Please note that the contents of this manual may not fit completely with actual vehicle due to the change of vehicle specification.

CONTENTS

0.Rescue sheet(s)	P.3
1.Identification / recognition	P.4
2.Immobilisation / stabilization / lifting	P.9
3.Disable direct hazards / safety regulations	P.12
4.Access to the occupants	P.17
5.Stored energy / liquids / gases / solids	P.21
6.In case of fire	P.22
7.In case of submersion	P.23
8.Towing / transportation / storage	P.24
9.Important additional information	P.28
10.Explanation of pictograms used	P.42

0. Rescue sheet(s)



OUTLANDER PHEV
 Body type: Station wagon
 Type: GG3W Model year: 2021

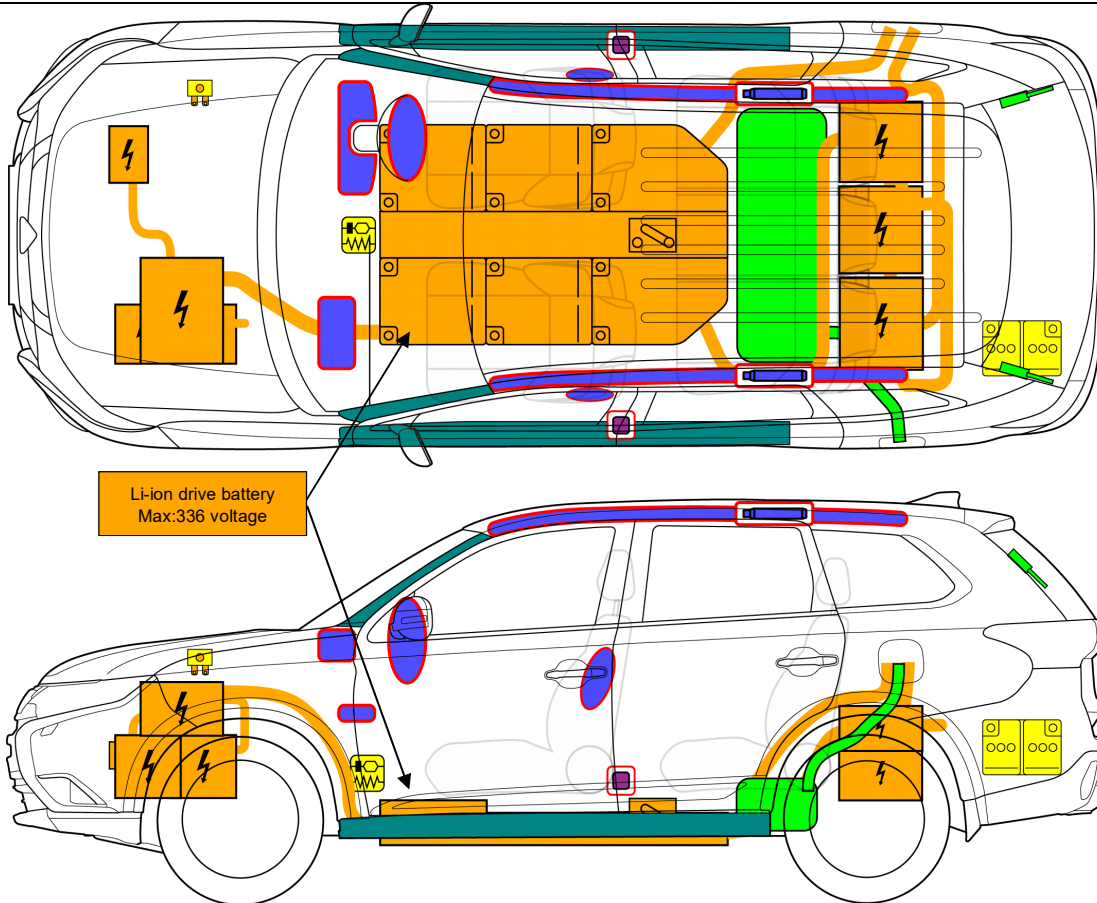

	Airbag		Stored gas inflator		Seat belt pretensioner		SRS control unit		Pedestrian protection active system
	Automatic rollover protection system		Gas strut / Preloaded spring		High strength zone		Zone requiring special attention		
	Battery low voltage		Ultra capacitor, low voltage		Fuel tank		Gas tank		Safety valve
	High voltage battery pack		High voltage Power cable component		High voltage disconnect		Fuse box disabling high voltage system		Ultra capacitor, high voltage
				ID No.	Version No.	Version Date.	Page		
				GGW-TNRS-02	01	09/2020	1		

1. Identification / recognition

1. Features on vehicle exterior

OUTLANDER PHEV shares one vehicle body with petrol engine models. Therefore, their exteriors are very similar. If you find any of the following features which can identify OUTLANDER PHEV, always wear appropriate Personal Protective Equipment (PPE).

WARNING;

- Use insulating Personal Protective Equipment (PPE) (Rubber insulating gloves, Rubber soled insulating shoes: rated to a minimum of 500V voltage resistance), when contact with the vehicle body is possible, until you can identify whether the vehicle is OUTLANDER PHEV or not.
- Engine noise does not always mean that the vehicle is a model with petrol engine.

(1) Feature list

It can be judged from the "PHEV (PLUG-IN HYBRID EV)" logo, battery charging lid, chassis number (model code), and power drive unit (PDU) cover.

The "PHEV (PLUG-IN HYBRID EV)" logo is installed on the left and right sides of the fender panel and on the tailgate.

(2) Features on exterior

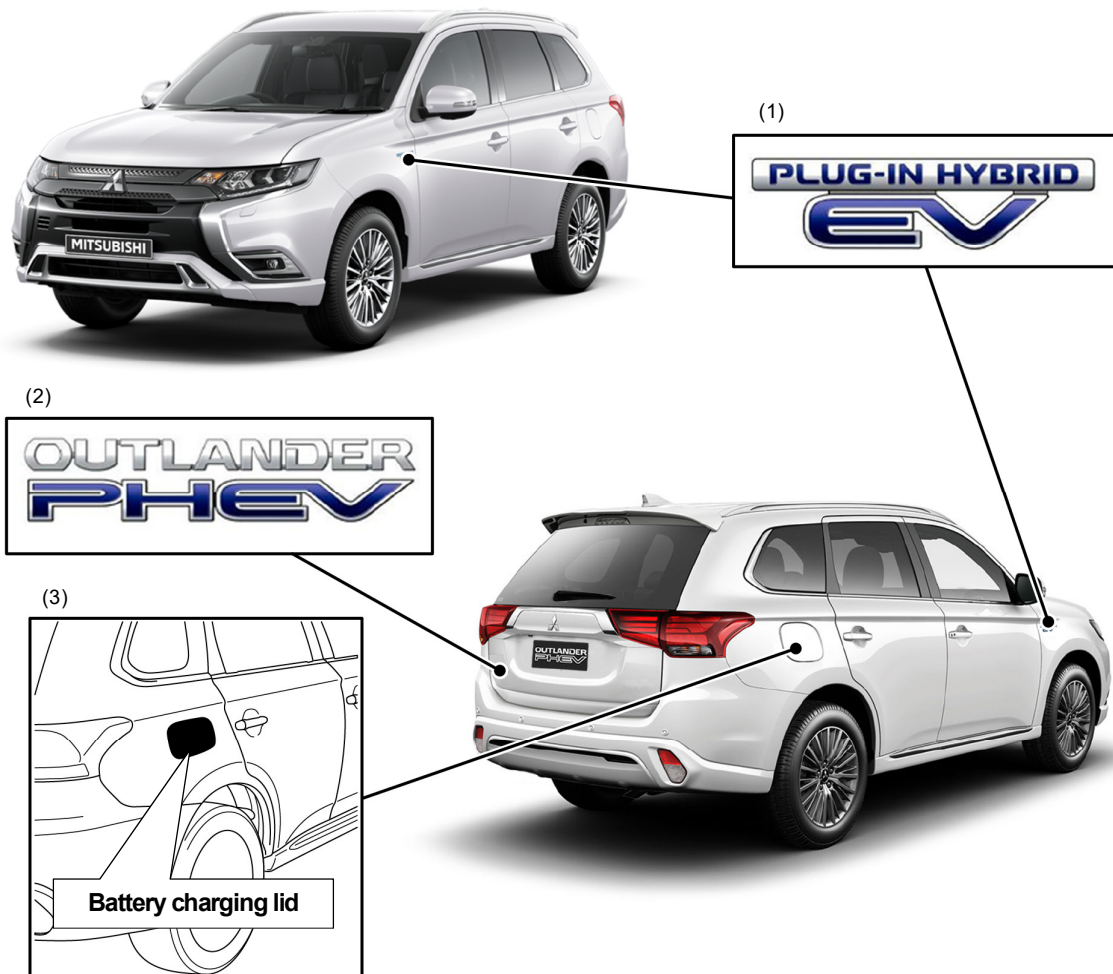

- (1) "PLUG-IN HYBRID EV" logo mark on the left and right front fenders
- (2) "PHEV" logo mark on the tailgate
- (3) "Battery charging lid" on the right rear panel

NOTE;

There is no Battery charging lid except for PHEV vehicles. The left rear panel is the "Fuel filler lid".

(1)

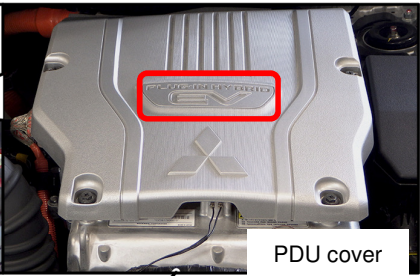
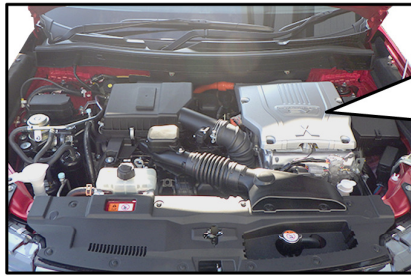

(2)



(1) "Chassis number" shown in the engine compartment

(2) "PLUG-IN HYBRID EV" logo mark on the "PDU cover" in the engine compartment

2. High voltage wiring harness location

High voltage wiring harness are located as shown in the figure below.

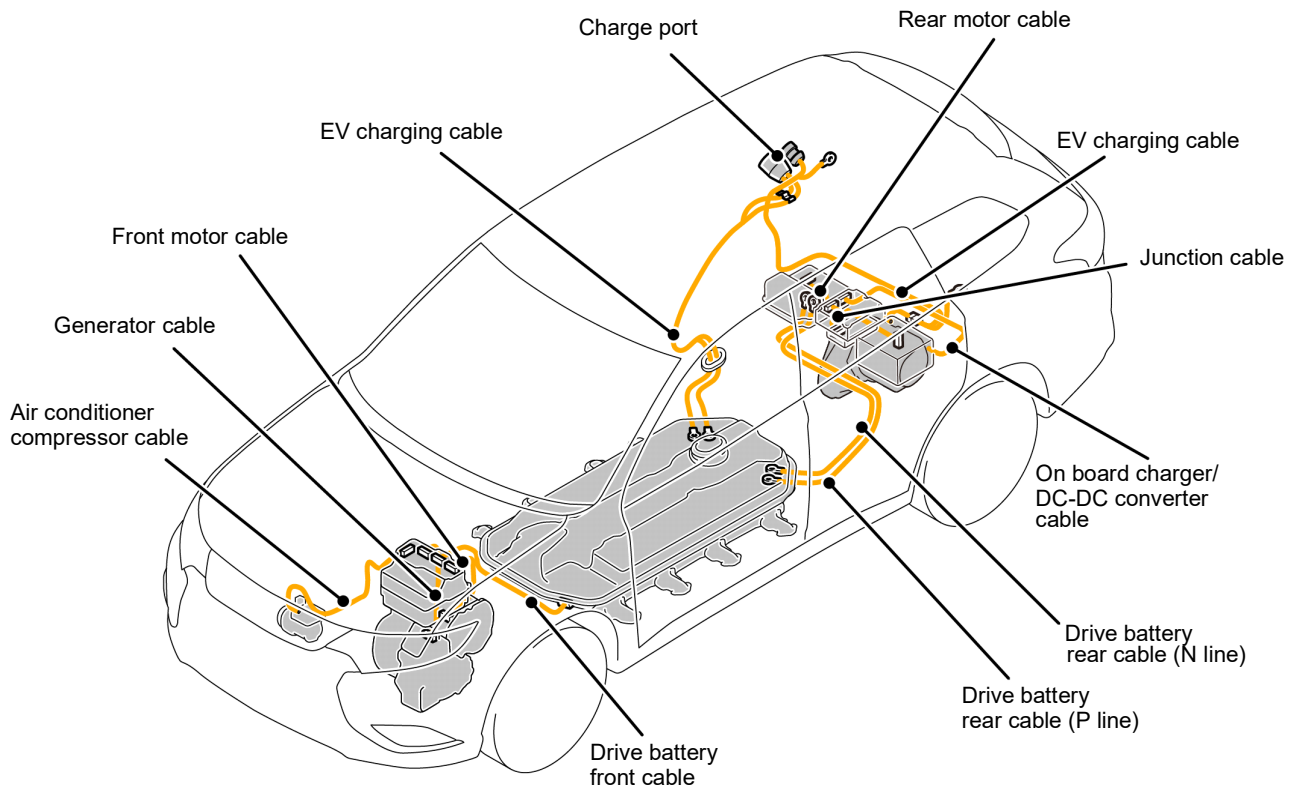

*: Refer to "10. Explanation of pictogram used"

3. Supplemental Restraint System (SRS) airbag component location

SRS airbags system (location of airbags and related components) are located as shown in the figure below:

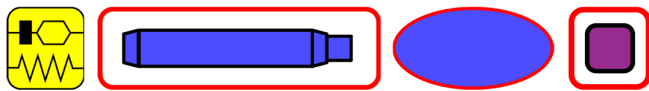
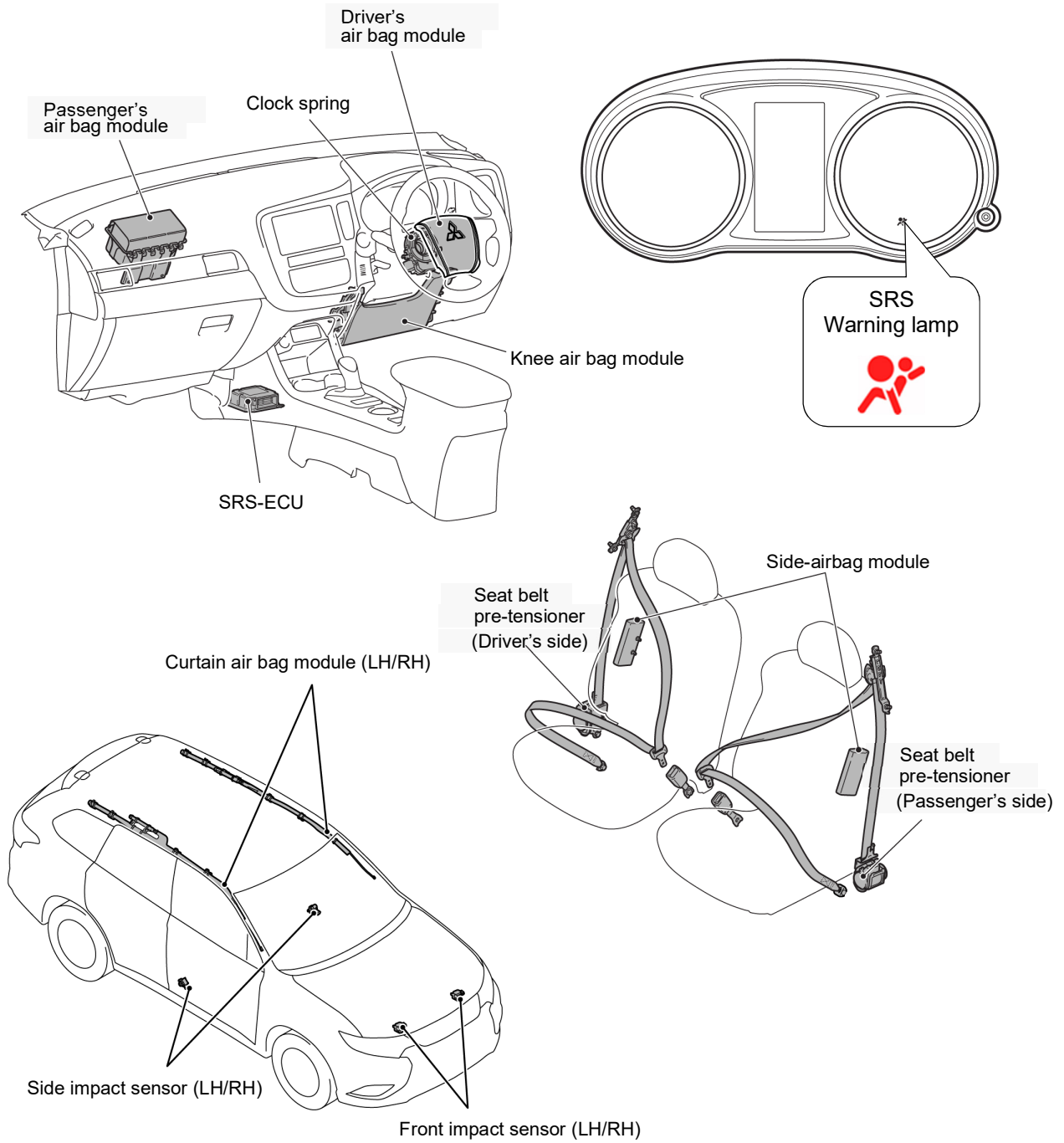

*: Refer to "10. Explanation of pictogram used"

4. Vehicle dimensions

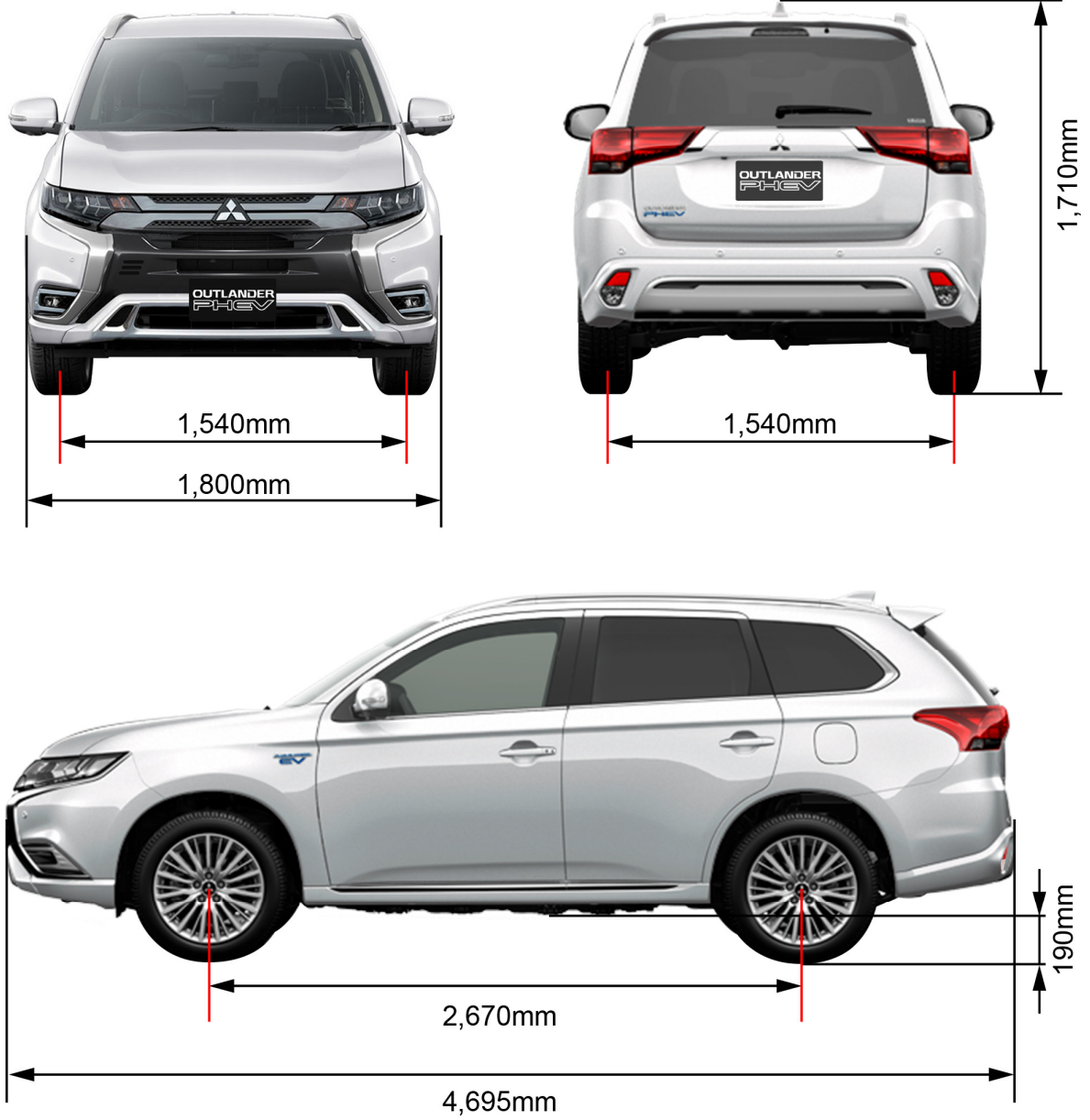

Vehicle weight : 1,915 – 1,930kg*

* : Differs on the model, the vehicle weight will change.

2. Immobilisation / stabilization / lifting

1. How to determine if vehicle is ON / OFF.



The operating range is the interior of the vehicle.

OFF

Check that the illumination of the "indicator lamp" and "combination meter" is off.

ON

The indicator lamp on the power switch illuminates blue.

The indicator light illuminates for a few seconds and goes off when the Plug-in Hybrid EV System is operating.

When the power switch is "ON", "combination meter" light up.

If you press the power switch without pressing the brake pedal while the vehicle is stationary, you can change the operation mode in the order of "OFF", "ACC", "ON", "OFF".

READY Indicator

The READY indicator keeps flashing until Plug-in Hybrid EV System is activated.

When the Plug-in Hybrid EV System has activated normally and the vehicle becomes ready to run, the lamp stops flashing and stays lit.

The driver can start driving when the READY indicator lit.

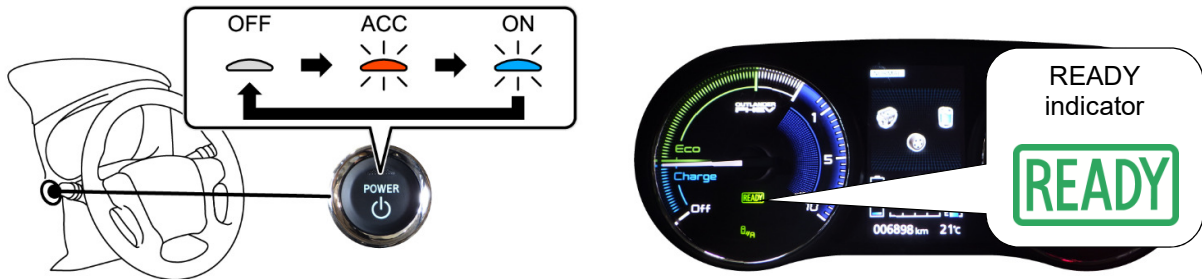

2. Support positions for Jack and Lift

CAUTION;

- Be sure to support the specified locations only. Otherwise, deformation of vehicle may occur.

Front suspension crossmember

Rear suspension crossmember

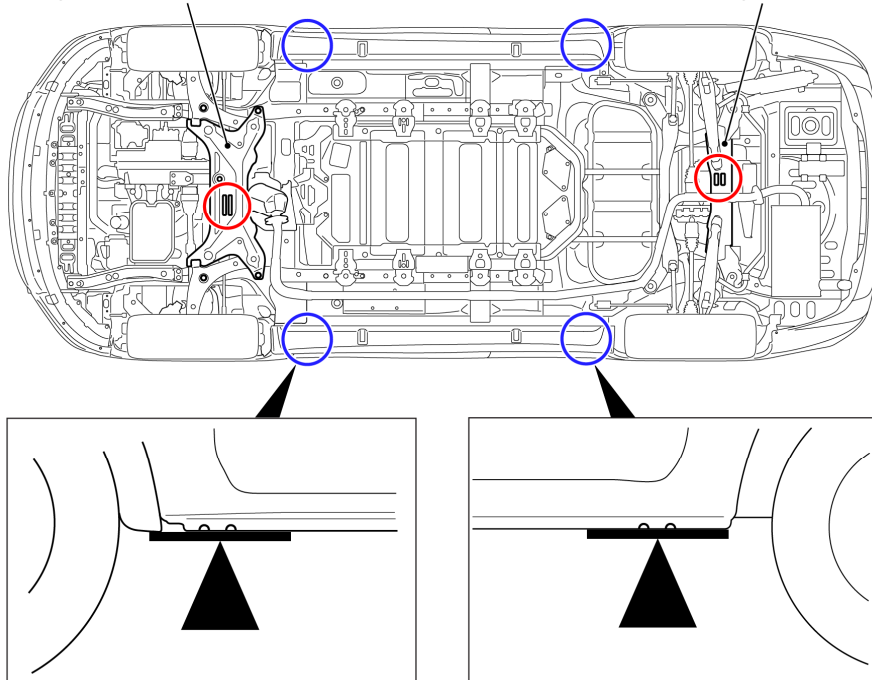

○:Support position for Garage Jack ○:Support position for Jack or Axle stands or Lift.

3. Vehicle Immobilization and Stabilization

WARNING;

- When installing a "block" or "lift airbag device", avoid high-voltage parts, exhaust systems and fuel systems, etc.
- If high-voltage components or high-voltage harnesses are exposed, do not place any support on them. It may cause damage or fire for vehicle.

NOTE;

When the 12V auxiliary battery is weak or dead or disconnect to terminal the Electric parking brake cannot be applied or released.

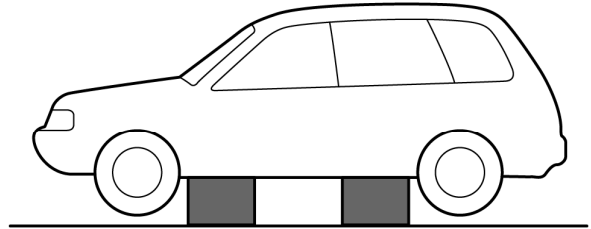
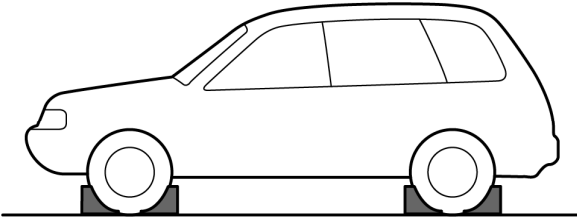

NE0040EEM0

Immobilization with wheel chocks

Park the vehicle and press the Electric parking switch.

Pull up the Electric parking brake switch while depressing the brake pedal, Check for the indicator lamp (Red) on the combination meter will come on.

Once the wheels are locked, lock the vehicle with the wheel chocks.

CAUTION;

- When applying the electric parking brake, stepping on the brake pedal firmly, stop completely the vehicle, and then pull up the switch.

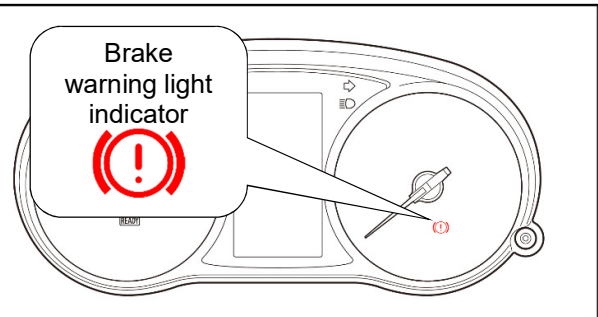

Stabilize with block

To stabilize the vehicle, place a support such as a block for under the vehicle and release air from tires to stabilize the vehicle.

When fixing the vehicle to the foundation, use the designated position of the jack.



*: Refer to "10. Explanation of pictogram used"

How to Stabilization a rollover or an overturned vehicle

⚠ CAUTION;

- Use a support that is strong enough.
- When installing prop tools, avoid exhaust systems, fuel systems, high-voltage parts, high-voltage harnesses, etc.
- If the inside of the high-voltage components or the high-voltage harness is exposed, avoid the exposed parts when installing.

-Stabilization method for prop tools of rollover vehicle

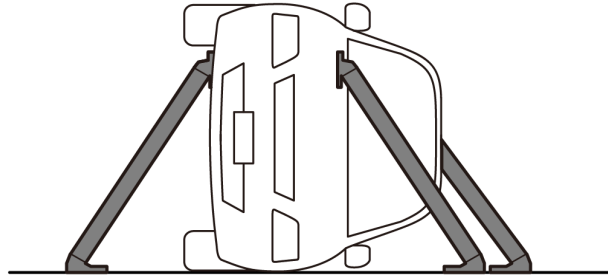

NE0073EJM0

Please support the prop tools on the vehicle roof or the vehicle bottom. Depending on the situation, support the prop tools with 2, 3, or 4 to stabilize it.

-Stabilization method using blocks, etc. of rollover vehicle

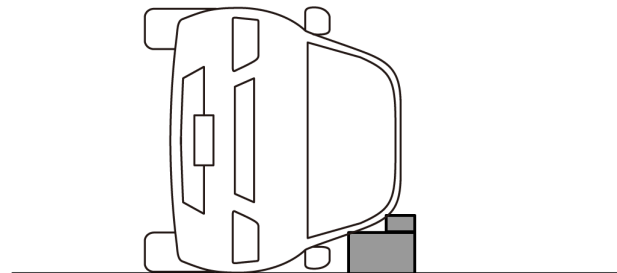
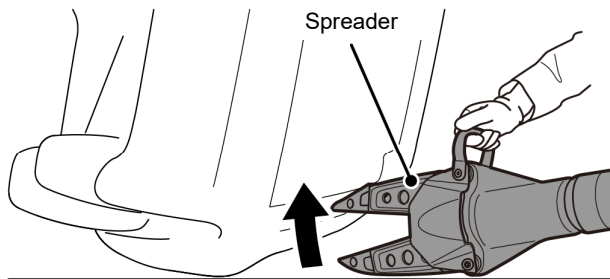

NE0072EJM0

If needed to up the vehicle, use a spreader or jack, etc., and place supports such as blocks in the gap to stabilize it.

-Stabilization method using wheel stoppers, blocks, props, etc. of overturned vehicle

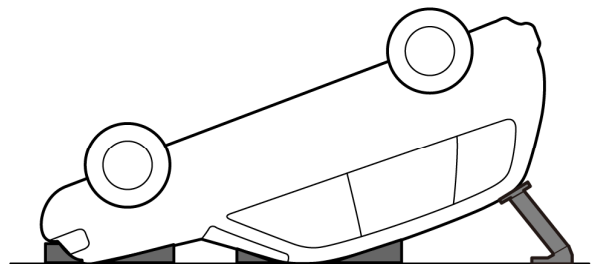
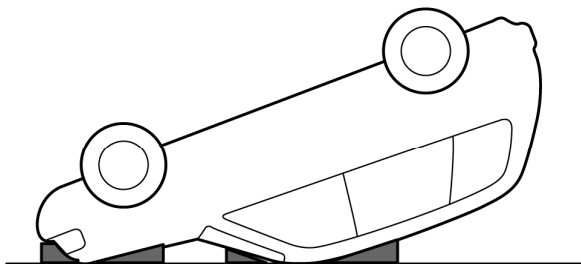

NE0076EJM0

Blocks or wheel stoppers are set up in the gap between the hood and pillars to stabilize the vehicle. When to increase the stability, place a column at the rear of the vehicle (a strong place) to stabilize it.

3. Disable direct hazards / safety regulations

NOTE;

Disconnecting the 12V auxiliary battery may make it impossible to perform operations related to electrical components. Perform the necessary operations before removing the 12V auxiliary battery terminal.

The OUTLANDER PHEV is equipped with a lithium-ion battery of max. voltage 336V.

This is used to activate the electric motor unit and some components such as air conditioning.

Before rescue work can begin, it is necessary to ensure “isolation” and “cut off” from the high voltage circuit in order to prevent the risk of electric shock before handling the vehicle.

Drive battery specification is “13.8kWh lithium-ion, 300V”. Drive battery’s maximum voltage capacity is 336V when the Drive battery is being charged.

CAUTION;

Silence does not always mean that the hybrid system is turned off.

Ensure that the high voltage circuit is “isolated” or “cut off”.

(1) Isolation from the high voltage circuit

- 1) The high voltage circuit is insulated from the vehicle body.
- 2) All of high voltage components are covered up by cases and covers.
Note that high voltage wiring cables can be distinguished from normal wiring harness by their orange coloured insulation.
- 3) The cases and covers are insulated from the high voltage circuit inside.

(2) Disconnection of the high voltage circuit

- 1) This vehicle has a system which allows the high voltage current supplied from the drive battery to be isolated automatically if you cannot isolate the high voltage system due to service maintenance or an accident.
- 2) The high voltage circuit will be isolated by pulling the charging connector during the battery charging.

<Disconnection mode>

System Case	Manual mode		Automatic mode	
	Charging connector	Service plug	Electric motor switch linked	Collision sensing
Normal usage	N/A	N/A	Available	N/A
During inspection or maintenance	N/A	Available	Available	N/A
Collision accident	N/A	N/A	N/A	Available
During the battery charging	Available	N/A	N/A	N/A

(3) Precautions when rescuing passengers

WARNING;

Failure to follow these instructions may result in serious injury such as electric shock:

- (1) This vehicle is equipped with a high voltage system of max operation voltage 336V.
- (2) The possibility of a high volume electrolyte leak as a result of the drive battery damage is reduced by the design inside the drive battery.
- (3) Drive battery uses an electrolyte made of flammable “Carbonate ester solution of lithium salts”.
When reacting with moisture in the air, this electrolyte generates acidic organic vapour which is harmful to human body. Therefore, when handling this, please use appropriate Personal Protective Equipment (PPE) including mask for organic gas, solvent resistance gloves and eye protector and use appropriate caution.
- (4) Vehicles with Mitsubishi remote control have an 12V auxiliary battery charging and a remote climate control functions. Therefore, even if the indicator in the electric motor switch is off, the high voltage system may be active.

NOTE;

Disconnecting the 12V auxiliary battery may make it impossible to perform operations related to electrical components. Perform the necessary operations before removing the 12V auxiliary battery terminal.

1. Electric power windows / Door lock

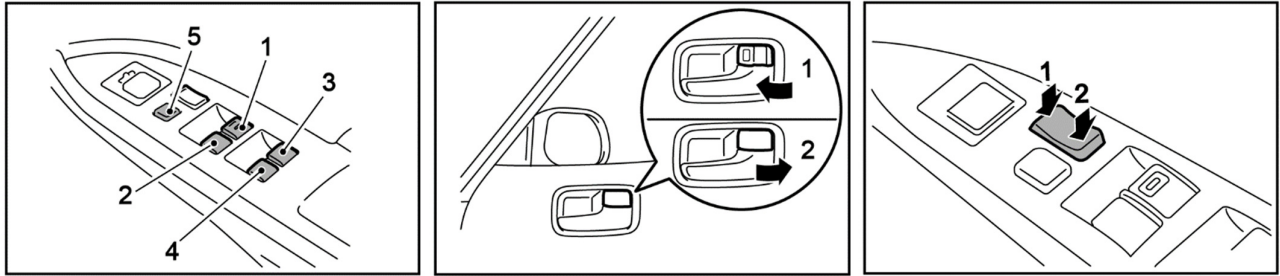

Power window

- 1 : Driver's door window
- 2 : Front Passenger's door window
- 3 : Rear left door window
- 4 : Rear right door window
- 5 : Window lock switch

Door lock

- 1 : Lock
- 2 : Unlock

NOTE;

When you operate the switch on the driver's side, all doors are locked / unlocked interlock.

2. How to parking brake to apply and parking brake release

-To apply

- 1) Pull up the Electric parking brake switch while depressing the brake pedal.
- 2) When the parking brake is applied, the brake warning light (red) in the instrument cluster will come on.



Make sure that the brake warning light (red) in the combination meter and the indicator light in the switch are lit.

CAUTION;

- When applying the electric parking brake, stepping on the brake pedal firmly, stop completely the vehicle, and then pull up the switch.

-To release

Manual operation

- 1) Make sure that the operation mode of the power switch is ON.
- 2) Press down the Electric parking brake switch while depressing the brake pedal.
- 3) When the parking brake is released, the brake warning light (red) go off.

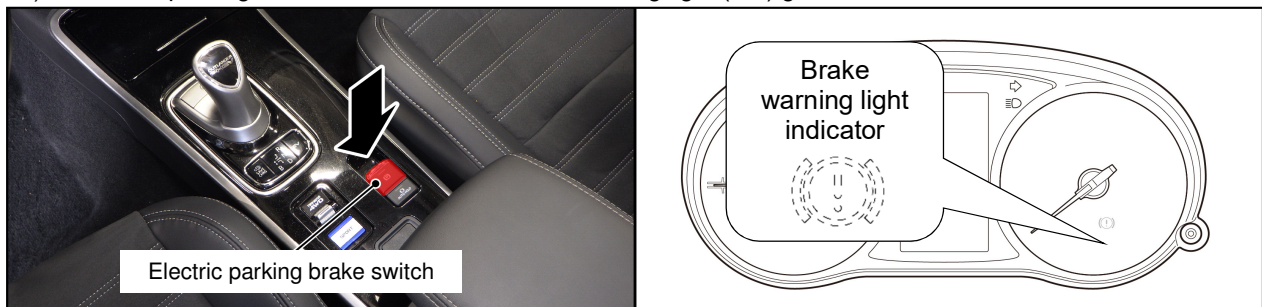

Automatic operation

When the accelerator pedal is depressed slowly while all of the following conditions are met, the Electric parking brake is automatically released.

- The Plug-in Hybrid EV System is operating.
- The select position is in the "D" (DRIVE) or the "R" (REVERSE) position.
- The driver's seat belt is fastened.

3. How to open hood

- 1) Pull the release lever towards you to unlock the hood.
- 2) Raise the hood while pressing the safety lock.
- 3) Support the hood by inserting the support bar in its slot.

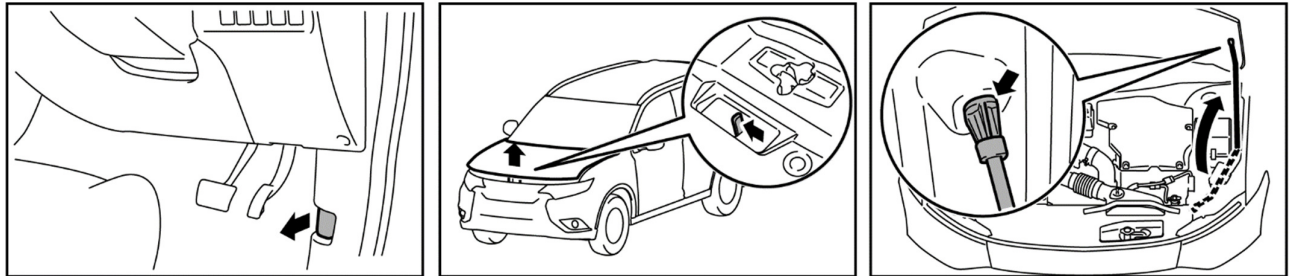

4. How to open tailgate

NOTE;

- The tailgate cannot be pulled up when you do not open it as soon as the tailgate open switch is pressed. In this case, push the tailgate open switch once again and pull up the tailgate.
- When the 12V auxiliary battery is weak or dead or disconnect to terminal the Electric parking brake cannot be applied or released.

-To open from outside

Unlocking the tailgate, push the tailgate open switch (A) and pull up the tailgate.

Electric tailgate can be auto opened by pressing the open switch (A).

The electric tailgate can be closed by pressing the close switch (B) on the inside of the electric tailgate.

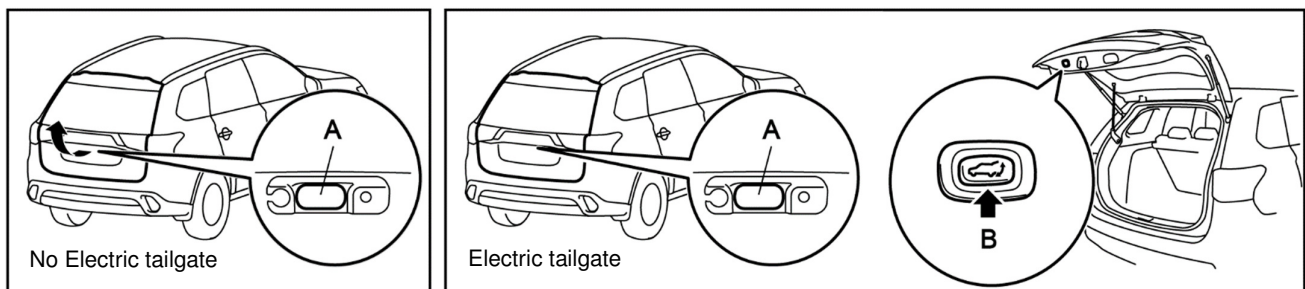

-To open from inside

The inside tailgate release is designed to provide a way to open the tailgate in the case of a discharged 12V auxiliary battery.

- 1) Open the lid (A) inside of the tailgate.
- 2) Move the lever (B) to push out on the tailgate to open it.

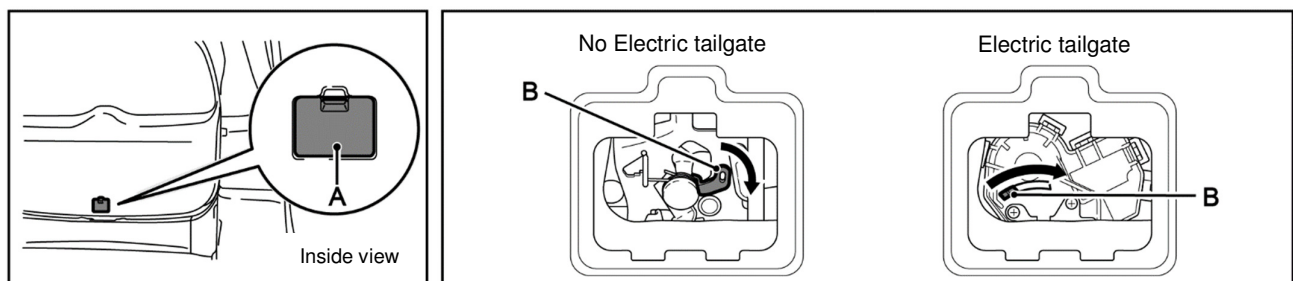

5. How to disconnect the “12V auxiliary battery

⚠ CAUTION;

The negative terminal disconnect for the 12V auxiliary battery should be 1 minutes later the power supply mode of the power switch is turned off.



Use an open end wrench (10 mm) to disconnect the negative terminal of the 12V auxiliary battery according to the procedure below, and then wrap a plastic tape around the disconnected negative terminal.

Shut down the SRS air bag system circuit by disconnecting the negative terminal of the 12V auxiliary battery.

- 1) Pull up the strap on the luggage floor box.
- 2) Remove the service lid of the 12V auxiliary battery.
- 3) Disconnect the 12V auxiliary battery negative terminal.

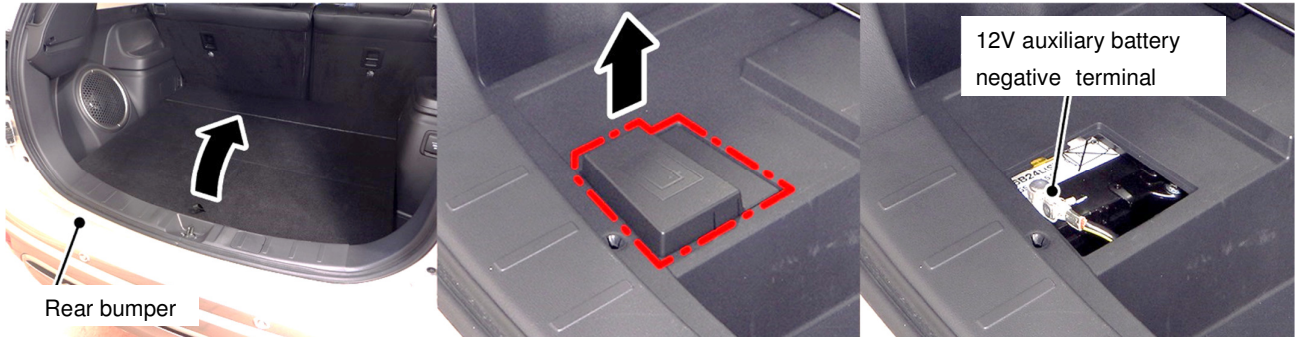

6. How to disconnect the “Power unit control” fuse

There is use a fuse remover to remove "Power unit control" fuses (10A in the illust below) from the engine compartment fuse box.

If you cannot locate this fuse, remove all fuses and relays in the fuse box.

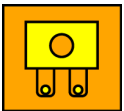
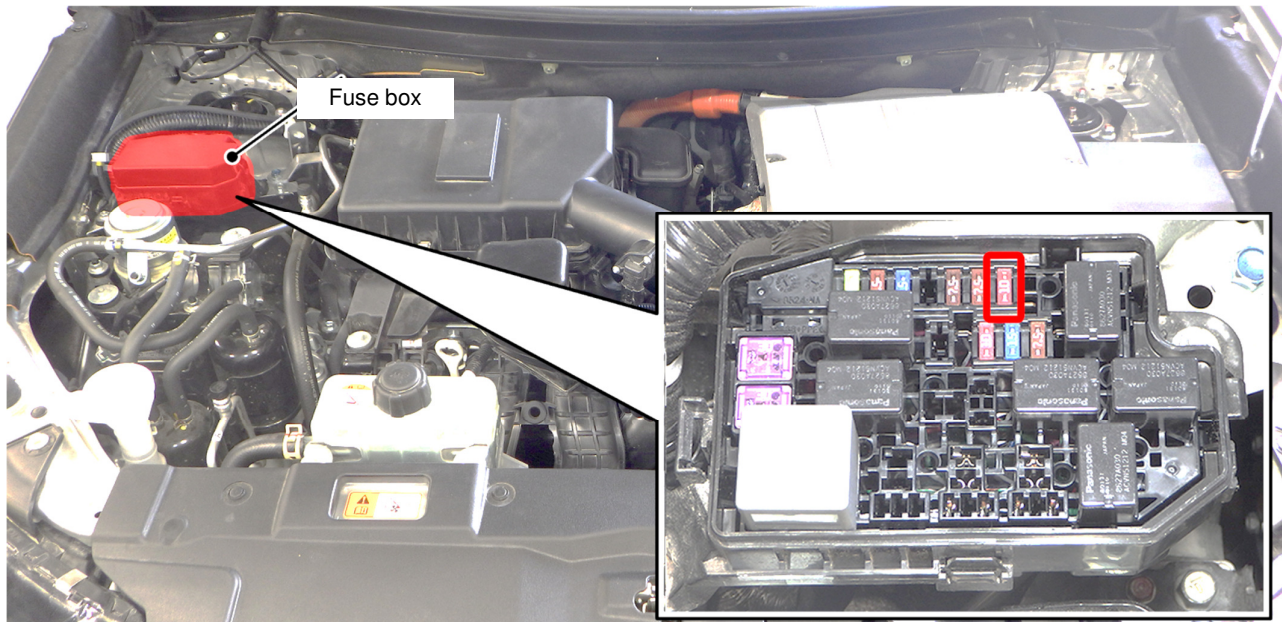

*: Refer to “10. Explanation of pictogram used”

7. How to shut down High voltage (pull out the service plug)

CAUTION;

Do not remove the service plug for 5 minutes later disconnecting the 12V auxiliary battery negative terminal.



- 1) Wear Personal Protective Equipment (PPE) and observe the procedure below to remove the service plug.
Pulling out the service plug will shut down the high voltage circuit in the drive battery.
- 2) Remove the service lid cover in the footwell under the middle of the second seat. (four clips)
Use an open end wrench (10mm) to remove the service lid. (four nuts)

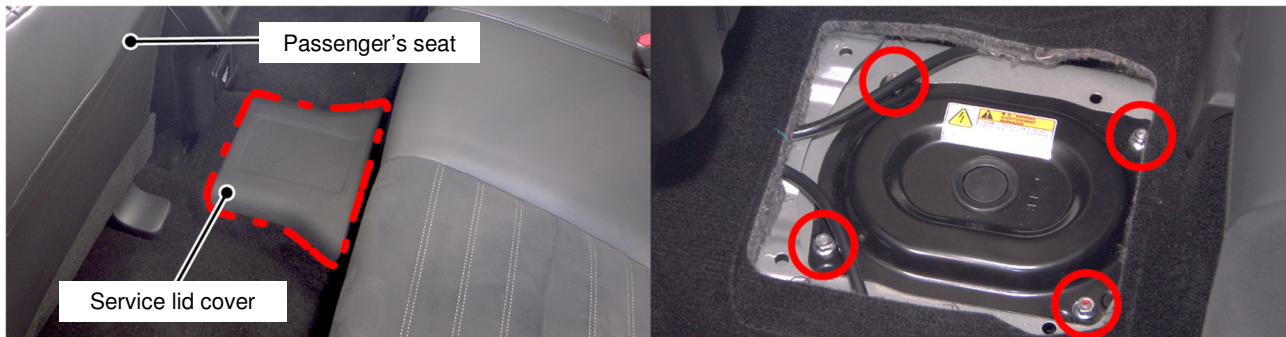

WARNING;

Always wear Personal Protective Equipment (PPE) when pulling out the service plug.



- 3) Wear Personal Protective Equipment (PPE) and remove the service plug.
 1. Raise the lever of the service plug until it stops.
 2. Raise the service plug while releasing the lever lock of the service plug.
 3. Pull the service plug upward to remove it.

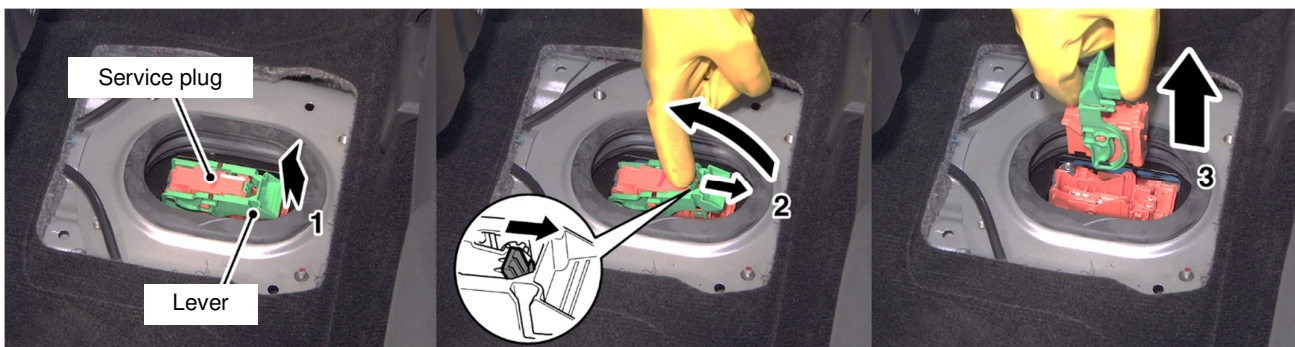

*: Refer to "10. Explanation of pictogram used"

4. Access to the occupants

Failure to follow these instructions when performing a rescue may result in serious injury such as electric shock. Do not touch high voltage cable or components. Isolate high voltage circuits as necessary.

NOTE;
 Disconnecting the 12V auxiliary battery may make it impossible to perform operations related to power seat. Perform the necessary operations before removing the 12V auxiliary battery terminal.

WARNING;
 Use insulating Personal Protective Equipment (PPE) (Rubber insulating gloves, Rubber soled insulating shoes: rated to a minimum of 500V voltage resistance) when you may touch the vehicle body directly or indirectly.



CAUTION;
 •When the 12V auxiliary battery is low voltage, or disconnected and removed, the tailgate, power seat, Electric component such as the electric parking brake cannot be operated.

1. Windows

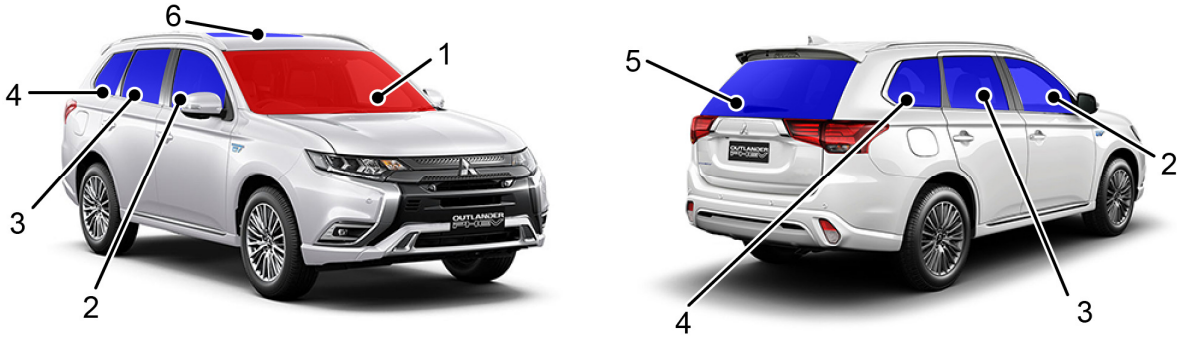

1 : Laminated glass 2 – 6 : Tempered glass

2. Adjustment seat and steering wheel

•Seat

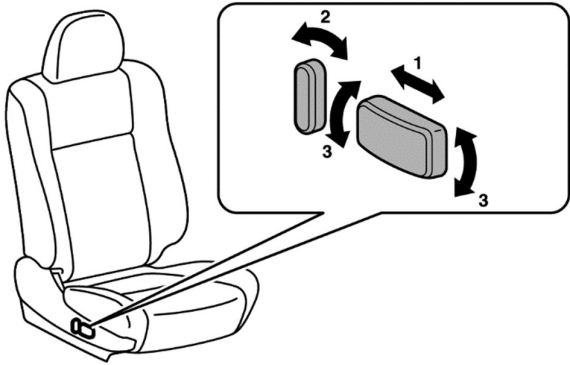

1 : To adjust forward or backward
 2 : To recline the seatback
 3 : To adjust seat height



*: Refer to "10. Explanation of pictogram used"



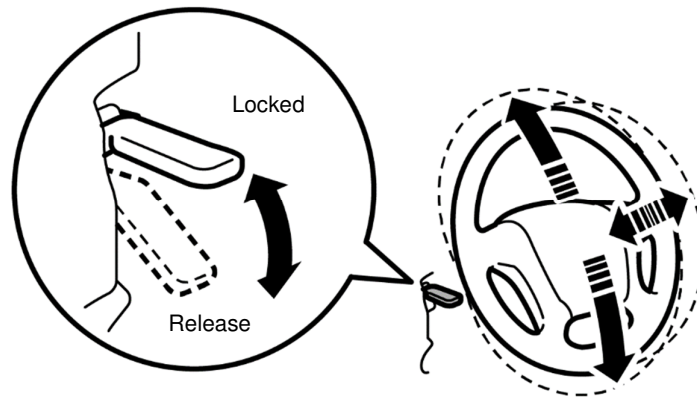

-Steering wheel

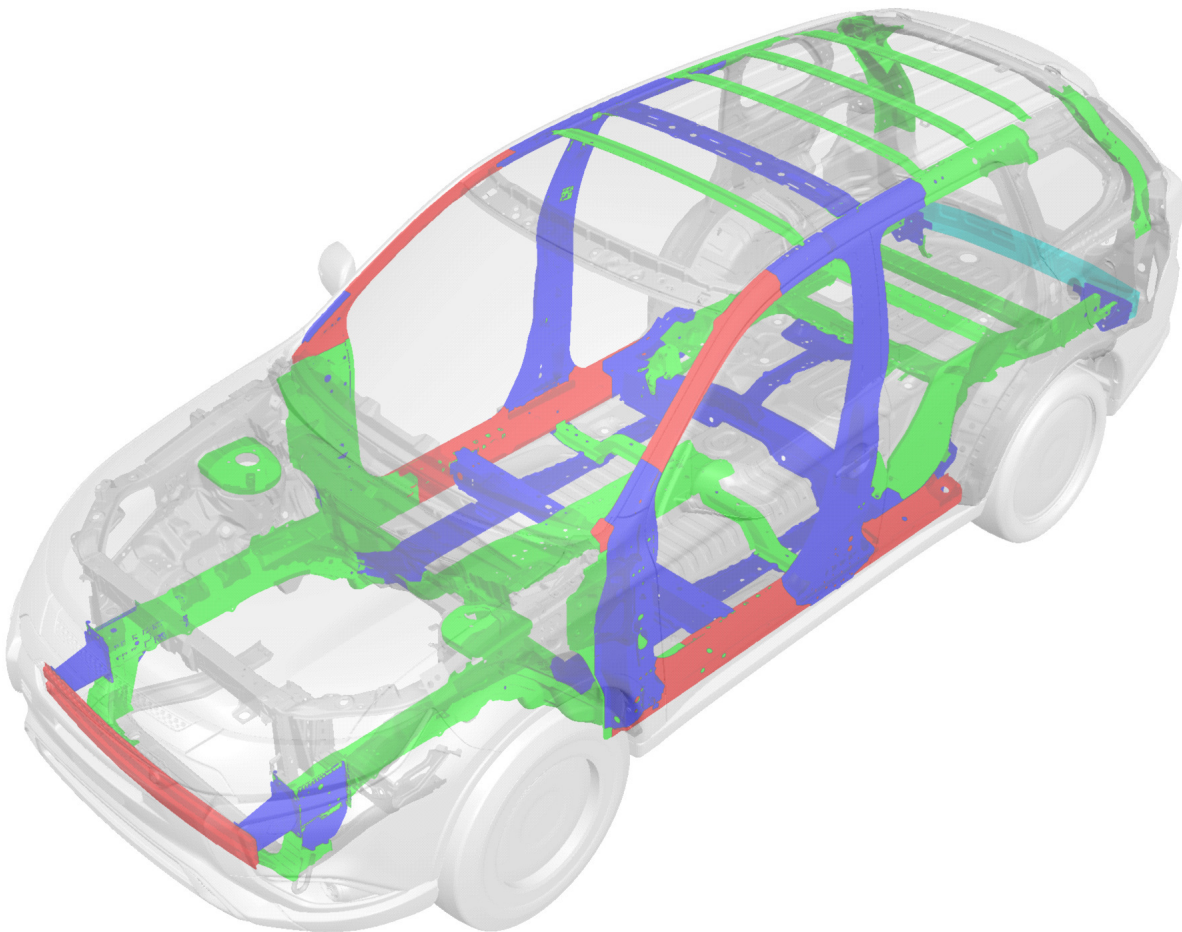

*: Refer to "10. Explanation of pictogram used"

3. High-tensile and Ultra-high-tensile steel panels location



 :440Mpa	 :590Mpa	 :980Mpa	 :Aluminum
---------------------------------------------------------------------------------------------	---------------------------------------------------------------------------------------------	---------------------------------------------------------------------------------------------	-------------------------------------------------------------------------------------------------

4. Vehicle CUT Zones



If you need to cut the car body, cut the car body and perform rescue work.

- Preliminary confirmation

Read this page and "1-2. High-voltage component and wiring harness location" before cutting the vehicle body.

⚠ WARNING;

- Use a hydraulic cutter or a suitable tool which does not generate sparks to cut the vehicle body. If you fail to do this, you or the passengers may be seriously injured.
- Never touch any exposed orange-colour high voltage wiring cables (cutoff or break a plastic jacket), or the portions shown in the figure.
- NEVER cut the drive battery.

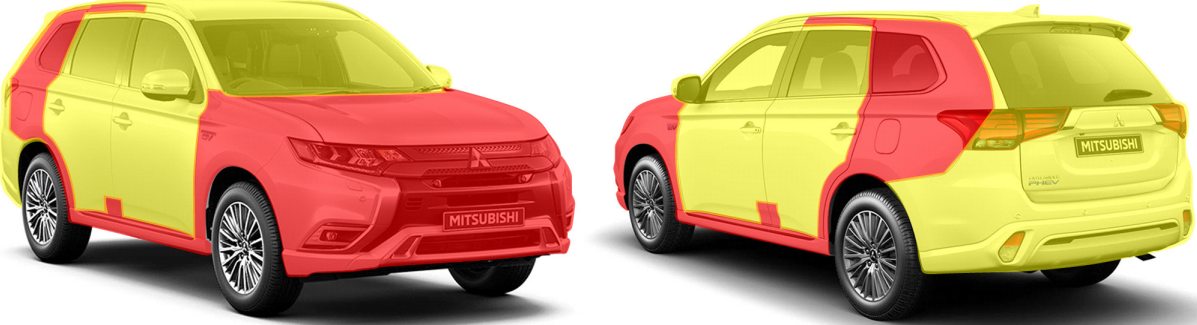
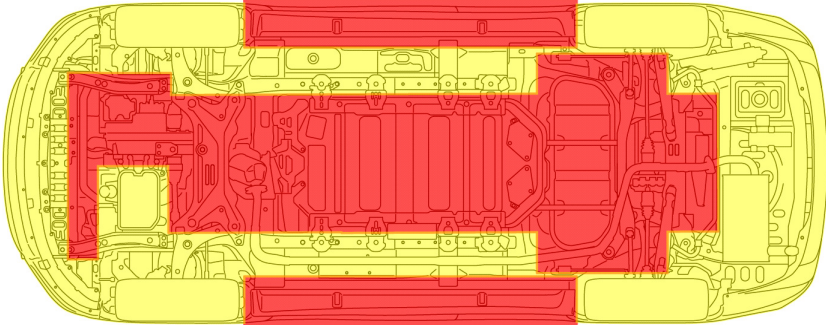
	<p><u>Risk of high voltage shock</u> Never cut this area in vicinity of the high voltage components and cables as an electric shock may occur.</p> <p><u>Risk of airbag deployment</u> Do not cut this area because there is risk that an airbag may be deployed due to a short circuit or an impact caused by the accident. If an airbag has already been deployed, this area can be cut. If at least one minute has elapsed after disconnecting the negative terminal of 12V auxiliary battery or turning off the ignition switch, this area can be also cut.</p>
	<p><u>CUT ZONE</u></p>
	
<p>← Front of vehicle</p>	
<p>Bottom view</p>	

5. Opening the door with a spreader or cutter

⚠ WARNING;

- Use a hydraulic cutter or a suitable tool which does not generate sparks to cut the vehicle body. If you fail to do this, you or the passengers may be seriously injured.
- Never touch any exposed orange-colour high voltage wiring cables. (cutoff or break a plastic jacket)
- NEVER cut the drive battery.

If you cannot open the door from the outside, use a spreader, cutter, etc. to rescue the door if necessary.

- 1) Insert the tip of the spreader into the door latch and open the spreader to make a gap.
- 2) If necessary, compress the front fender with a spreader to make a gap in the door hinge part.
- 3) Insert the cutter into the gap between the door hinges created, to break it hinges and open the door.

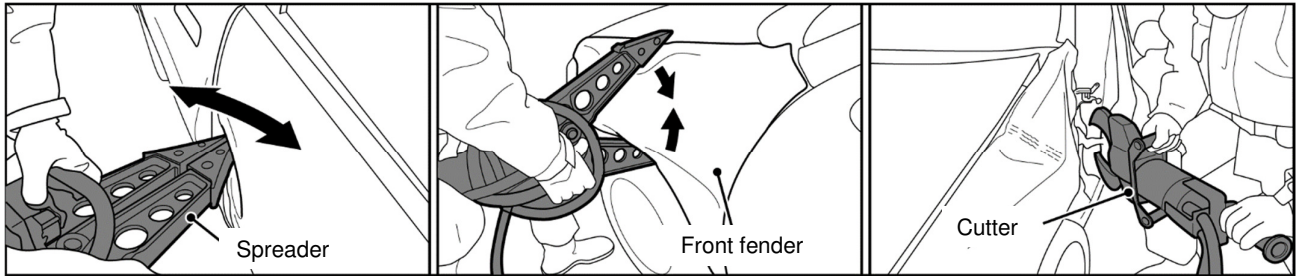

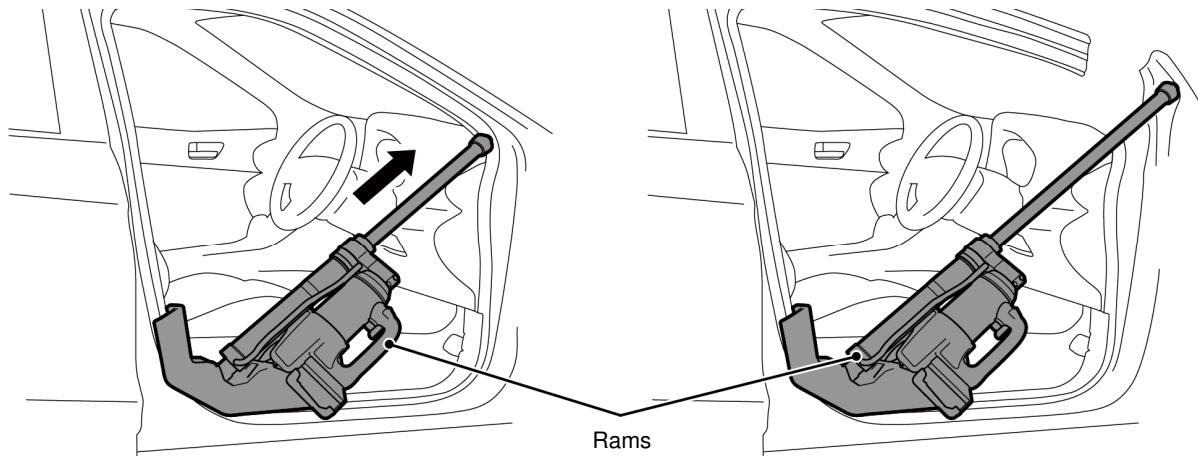

6. Securing space by rams

If the body is crushed and you cannot rescue the occupant, use a rams on the crushed part to push the body wide and secure a space for rescue. If necessary, cut the pillar part and expand it.

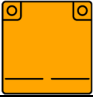
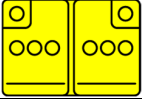

5. Stored energy / liquids / gases / solids

Fluids / gases used in this vehicle

	Capacity	Colour
Fuel tank (Petrol) 	45 liters	Light orange
Li-ion drive battery 	13.8 kWh	Clear & colourless
12V auxiliary battery 	36 Ah	Clear & colourless
Engine oil	4.3 liters (Oil pan) 0.3 liters (Oil filter)	Dark brown
Engine coolant	6.5 – 7.5 liters	Blue-green
Rear Motor coolant	6.5 liters	Blue-green
Brake fluid	As required	Clear or yellow or brown
Front Motor fluid	2.2 liters	Blue-green
Transaxle fluid	4.31 liters (Front : 3.46 liters / Rear : 0.85 liters)	Red
Refrigerant (air conditioner) 	R134a : 520 – 560g	Non colour



WARNING;

A flammable "carbonate solution containing lithium salt" is used as the electrolyte for the drive battery.



*: Refer to "10. Explanation of pictogram used"

Drive Battery information

Drive battery

- It is the battery to operate the motor and the air conditioning. In addition to the drive battery, OUTLANDER PHEV has the 12V auxiliary battery to operate lamps, wipers, etc.
- Compact, light-weight lithium ion battery with high energy density is used for the drive battery.

Precautions for rescue work

- The Plug-in Hybrid EV System uses high voltage up to **DC 336V**. The system can be hot during and after starting and when the vehicle is shut off. Be careful of both the high-voltage and the high temperature. Follow the warning labels that are attached to the vehicle.
- Always assume the high voltage battery and associated components are energized and fully charged.
- Never perform servicing and rescue when READY indicator is illuminating or when the charging indicator is illuminating or flashing because the high-voltage system is operating.

When there is deformation / damage

- If you detect leaking fluids, sparks, smoke, flames, gurgling, popping or hissing noises originating from the high-voltage battery component, contact emergency services immediately. This may result in a fire.
- Physical damage to the vehicle or high voltage battery may result in immediate or delayed release of toxic and/or flammable gases and fire.

6. In case of fire

1. Vehicle fire

In case of vehicle fire, alert fire department immediately and start extinguishing the fire using the following procedures where possible.

CAUTION;

Failure to follow these instructions may result in serious injury such as electric shock:

- 1) The drive battery is designed to prevent a substantial amount of electrolyte from leaking from the drive battery just in case it is broken.
- 2) The drive battery uses an electrolyte made of flammable "Carbonate ester solution of lithium salts".
When reacting with moisture in the air, this electrolyte generates acidic organic vapour which is harmful to human body.
- 3) Therefore, when handling this, please use appropriate Personal Protective Equipment (PPE) including mask for organic gas, solvent resistance gloves and eye protector and use appropriate caution.



*: Refer to "10. Explanation of pictogram used"

2. Fire-extinguishing



Use ABC powder fire extinguisher or large quantity water to extinguish the fire

WARNING;

·Never use seawater or any water containing salt.

- 1) By using fire extinguisher

Use a fire extinguisher which is suitable for flammable liquid and electrical equipment fires.

- 2) By using water

Use water not containing salt, such as tap water, well water or pond water.

DO NOT attempt to extinguish the fire with a small amount of water as it is dangerous.

Use large quantity of water.

A large volume of water, such as from a fire hydrant must be used. Unless a large volume of salt-free water is available, keep away from the vehicle fire and wait for fire department to arrive.



*: Refer to "10. Explanation of pictogram used"

7. In case of submersion

1. Submerged Vehicle



CAUTION;

If the drive battery and high voltage system are immersed in water, they will be treated as submerged.

If the vehicle is submerged or partially submerged, first pull the occupants out of the vehicle and water.

Then shut down the 12V auxiliary battery and high voltage system.

If the vehicle is submerged, water may enter the drive battery.

If the vehicle is submerged, the drive battery may generate flammable hydrogen gas.



WARNING;

• If water enters the driving battery, hydrogen gas may be generated.

• When seawater enters, a large amount of hydrogen gas is generated by rapid electrolysis due to salinity, which may cause a fire.

• If you after lift the vehicle, please open the windows and doors as there may be hydrogen gas in the car.

Rescue operation

Inspect the vehicle for damage.

If the vehicle is severely damaged, the drive battery is deformed, broken or exposed (or you cannot evaluate how severely the drive battery is damaged), wear insulated Personal Protective Equipment (PPE) and carry out the rescue operation while taking care not to touch the drive battery.

1. When the vehicle is severely damaged.
2. When the drive battery is deformed or damaged, and internal parts are exposed.
3. When the damage condition of the drive battery cannot be determined.



CAUTION;

If flushing the drive battery cannot be performed due to the damage of the drive battery etc., consult the nearest certified MITSUBISHI EV dealer how to flush the drive battery.

Necessary action after the rescue operation

- 1) When the tailgate does not open from outside. [\(Refer to 3-4\)](#)
- 2) Remove the "12V auxiliary battery negative terminal". [\(Refer to 3-5\)](#)
- 3) Remove the "Power unit control" fuses. [\(Refer to 3-6\)](#)
- 4) Remove the "Service plug". [\(Refer to 3-7\)](#)

- The drive battery is severely broken or exposed

Submerge the drive battery into the pool immediately according to "How to discharge measures by in pool" [\(Refer to 9-3\)](#) and leave it submerged for approx. 84 hours (3.5 days).

- The drive battery is not broken

Fill water not containing salt, such as tap water, well water or pond water into the drive battery to discharge it. "How to discharge measures by water injection" [\(Refer to 9-3\)](#)



*: Refer to "10 for the explanation of pictogram"

8.Towing / transportation / storage

1. How to Transport

Transport the vehicle on a flatbed truck or tow the vehicle with all wheels off ground.

- Vehicle dimensions. ([Refer to 1-4](#))



WARNING;

Never tow the vehicle with front wheels and/or rear wheels on the ground. This may cause damage to the electric motors and transaxle.



CAUTION;

If the 12V auxiliary battery charging level is too low or the 12V auxiliary battery negative terminal is disconnected, you cannot move the selector lever from the P range.

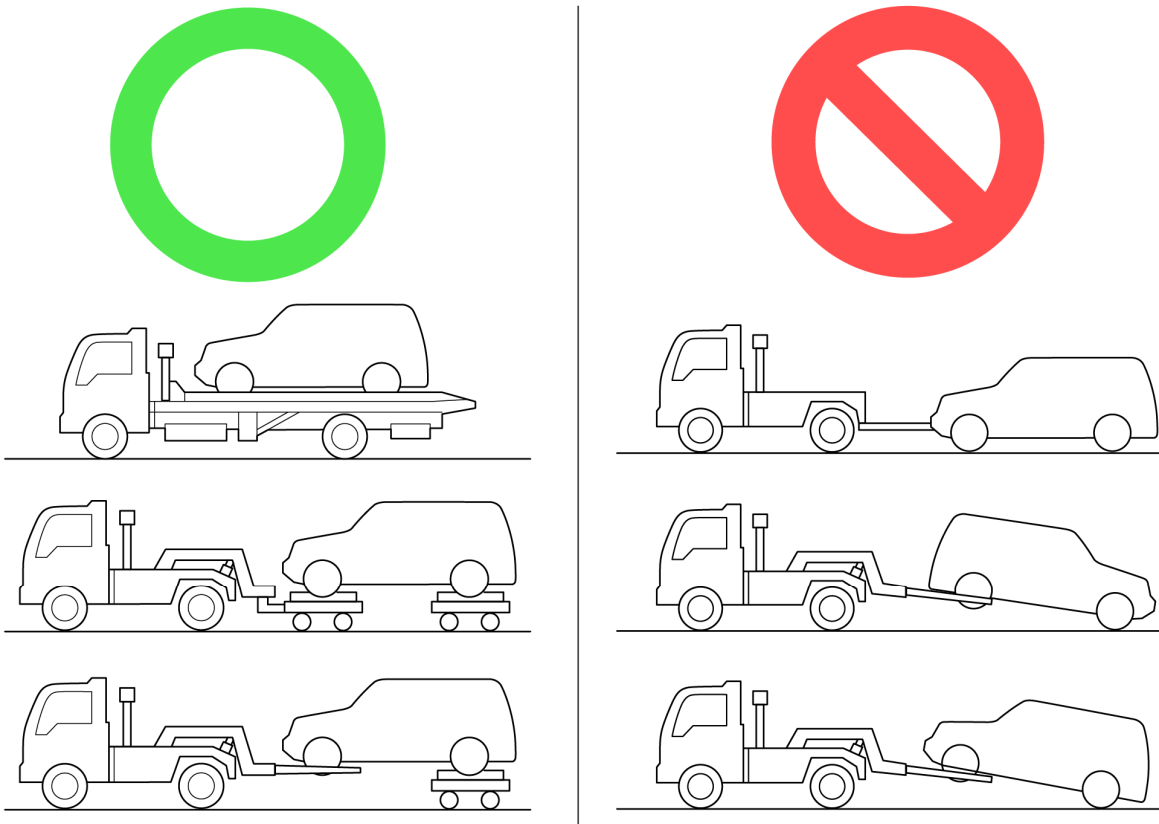

NE0024EEM0

- The illustration shows examples only.
- When loading the vehicle on the truck, handle carefully to prevent further damage.

2. How to Towing (only in emergency)

- 1) Hook a towrope to the tow hook of the vehicle body.
- 2) Start the Plug-in Hybrid EV System.
If the Plug-in Hybrid EV System cannot be started, put the operation mode of the power switch in "ON".
- 3) Move the select position in "N" (Neutral) position.
- 4) Press down the Electric parking brake switch while depressing the brake pedal.
The indicator in the combination meter will turn off.
- 5) Turn on the hazard warning lamps to if required by law. (Follow the local driving laws and regulations.)
- 6) During towing make sure that close contact is maintained between the drivers of both vehicles, and that the vehicles travel at low speed.



WARNING;

If the vehicle is towed with the operation mode in "ON" without starting the Plugin Hybrid EV System, the 12V auxiliary battery may be fully discharged during towing. In this case, the brake performance becomes very poor and the steering wheel becomes very heavy.



CAUTION;

•For vehicle equipped with the Adaptive Cruise Control system (ACC) and Forward Collision Mitigation system (FCM), stop these systems to prevent an unexpected accident or unexpected operation during towing.

(Refer to "To turn off FCM") (Refer to "To turn off ACC")

•When the vehicle is to be towed by another vehicle with all the wheels on the ground, make sure that the towing speed and distance given below are never exceeded, avoiding damage to the transaxle.

-Towing speed: 30 km/h (19 mph)

-Towing distance: 30 km (19 miles)

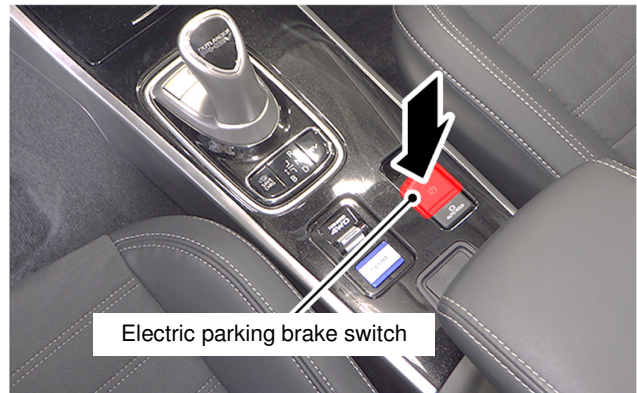

To turn off FCM

You can switch the system from ON to OFF if you hold the “FCM ON/OFF” switch pressed when the operation mode is set to “ON”.

When you turn off the system, the following message appears on the screen and  the indicator comes on.

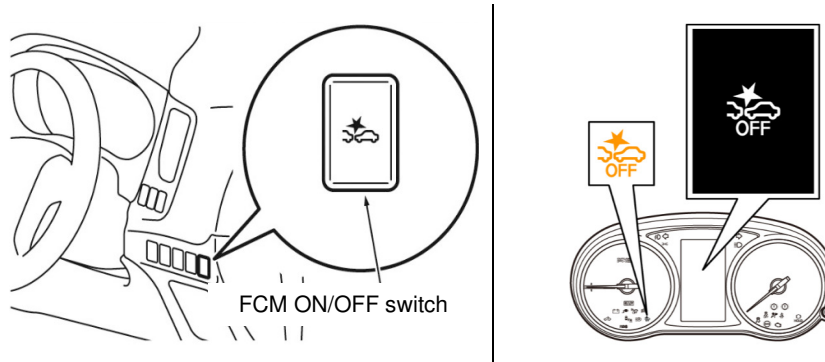

To turn off ACC

Press the “ACC ON/OFF switch” when ACC is in the ‘ON state’ to turn off ACC.

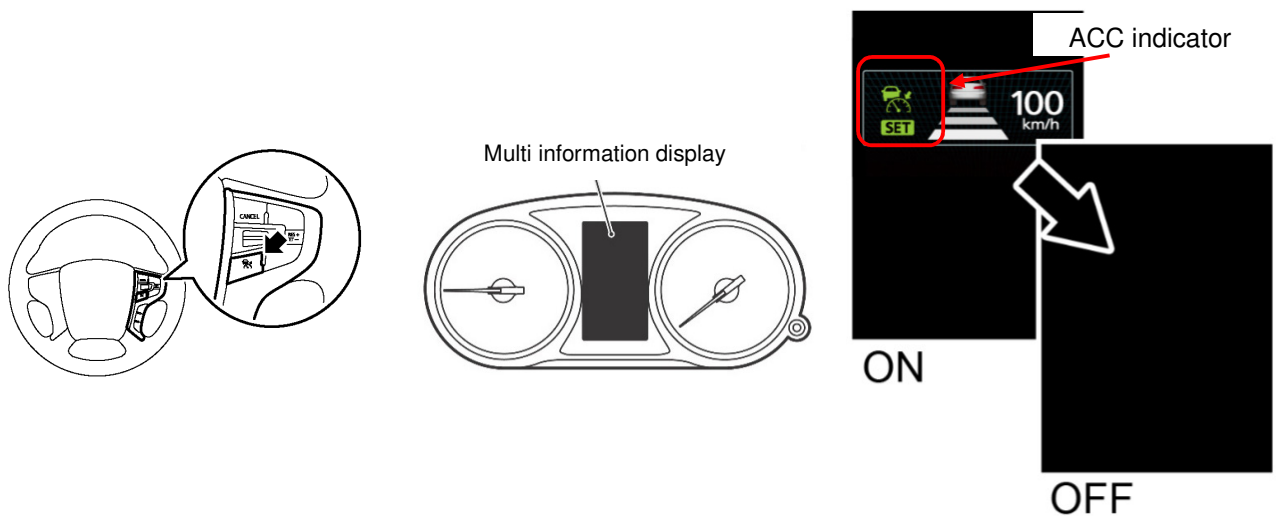

3. How to release the electric parking brake manually

⚠ CAUTION;

- The negative terminal disconnect for the 12V auxiliary battery should be 1 minutes later the power supply mode of the power switch is turned off.
- Releasing the electric parking brake manually is limited to an emergency case.



- 1) Park the vehicle, press the electric parking switch, and then chock the vehicle.
- 2) Disconnect the 12V auxiliary battery negative terminal.

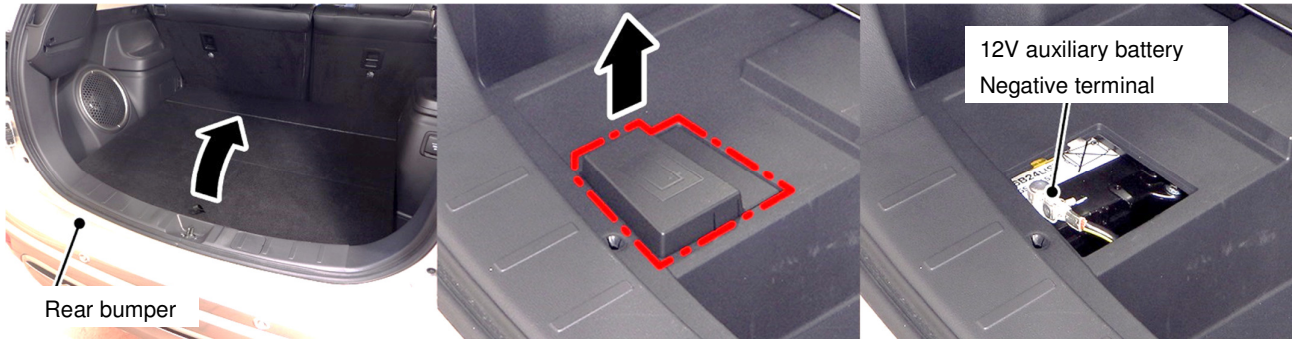

⚠ CAUTION;

- If signs of dirt or water are found around the connector, clean it thoroughly. Ensure that no foreign materials intrude into the connector.

- 3) Disconnect the wiring harness connector from the electric parking actuator.
- 4) Remove the two bolts to remove the electric parking actuator from the rear brake caliper assembly.

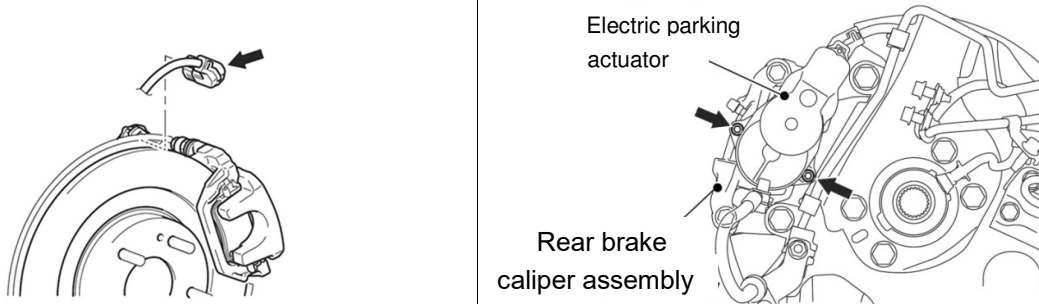

- 5) Insert a hexagonal wrench (6 mm) to the rear brake caliper assembly, and then turn the wrench clockwise 2 turns.

⚠ WARNING;

- Depress the brake pedal before releasing the parking brake. If not, the vehicle will start to move as soon as you release the parking brake.

⚠ CAUTION;

- The brake fluid may overflow.

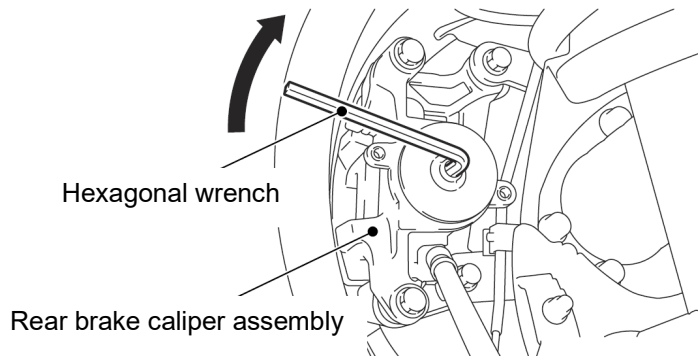

9.Important additional information

1. Supplemental Restraint System (SRS)

Supplemental Restraint System (SRS) airbag component location [\(Refer to 1-3\)](#)

Caution Labels

The labels indicating the precautions for handling and maintenance of SRS air bags and seat belt with pre-tensioner are attached to the locations shown in the figure. If the label is damaged or is dirty, replace with the new label.

Driver's air bag module

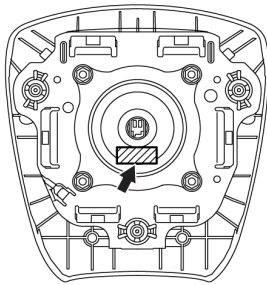

Passenger's (front) air bag module

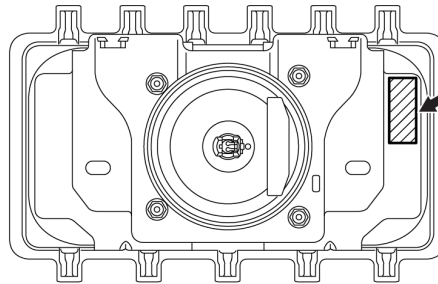

Sunvisor

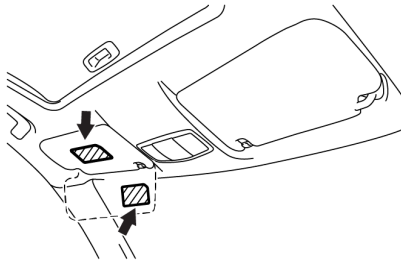

SRS-ECU

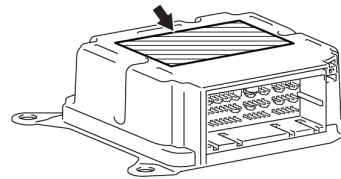

Side-airbag module (LH and RH)



Seat belt pre-tensioner
(Driver's side and passenger's side)

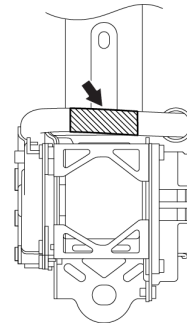

Knee air bag module

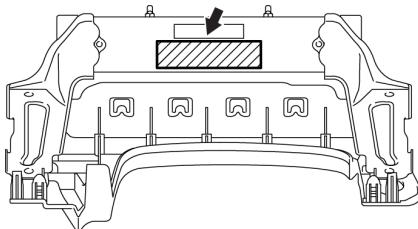

Curtain air bag module (LH and RH)

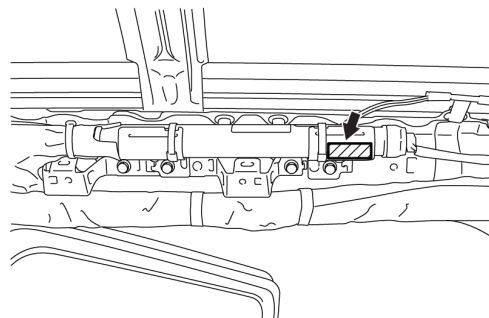

System Operation

AIR BAGS AND SEAT BELT PRE-TENSIONERS

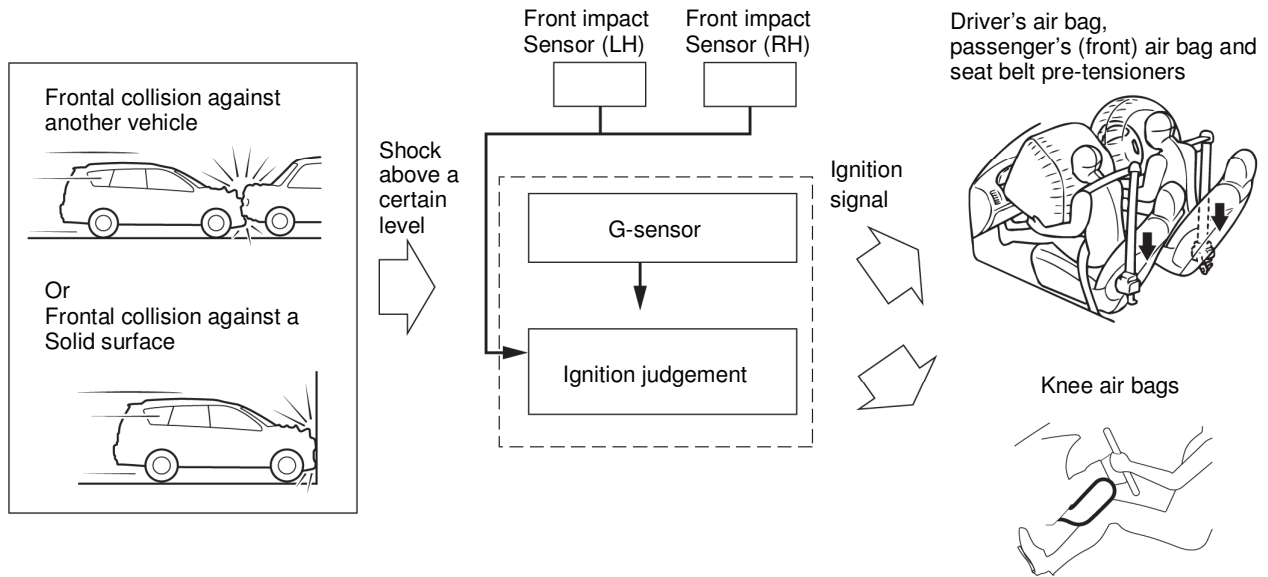

SRS-ECU uses data of the front impact sensor (in engine compartment) and G-sensor (in SRS-ECU) to calculate collision severity during frontal collision. SRS-ECU judges necessity of air bag based on the calculated collision severity. In addition, the SRS-ECU also judges the operation of knee air bag and seat belt pre-tensioner after calculating collision severity.

SIDE AND CURTAIN AIR BAGS

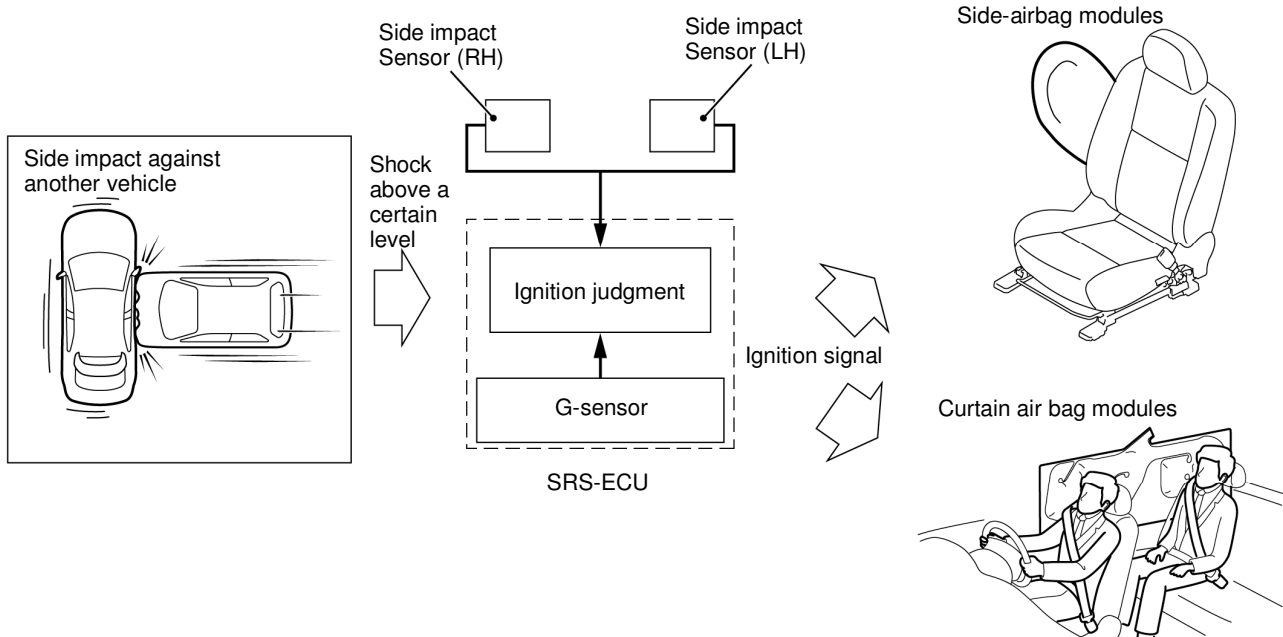

SRS-ECU uses data of the side impact sensor and G-sensor (in SRS-ECU) to calculate collision severity, during side collision. SRS-ECU judges necessity of side-airbag and curtain air bag based on the calculated collision severity.

NE0045EJM0

System Construction

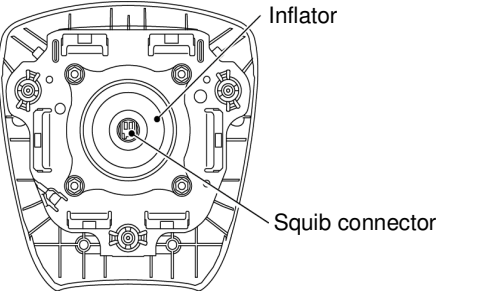
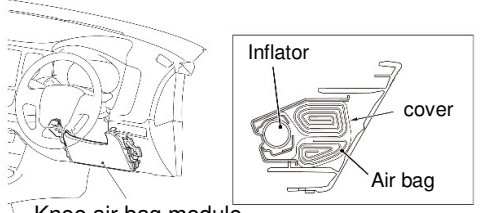
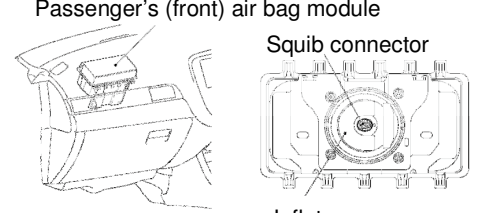
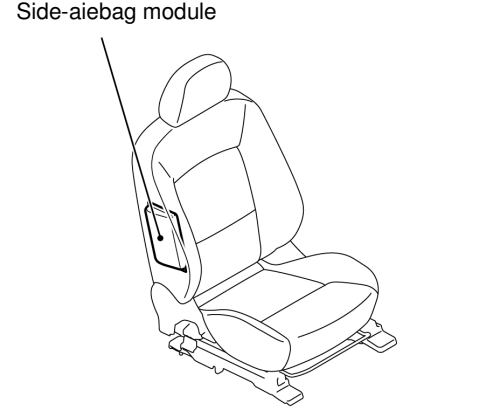
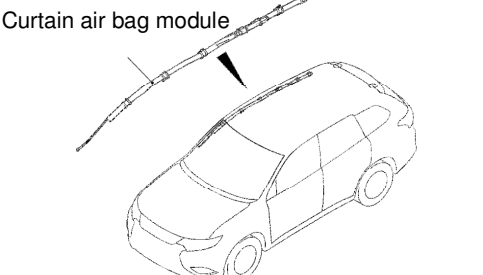
<p>DRIVER'S AIR BAG MODULE</p>	 <p>Inflator</p> <p>Squib connector</p>	<p>It incorporates an SRS airbag to protect the driver in the event of a frontal collision. The airbag module is equipped with an inflator that does not contain sodium azide. The air bag is made of nylon and is inflated by the gas from the inflator. Then, as the air bag contacts the passenger, the gas is discharged through two openings of backside of air bag, thus deflating the air bag to reduce the impact on the passenger.</p>
<p>KNEE AIR BAG MODULE</p>	 <p>Knee air bag module</p> <p>Inflator</p> <p>cover</p> <p>Air bag</p>	<p>The knee air bag module consists of a cover, an air bag, an inflator, and the fixing gear relating to those parts, and is installed under the steering column. Like the driver's and front passenger's air bags, the knee air bag is inflated upon a frontal collision for better protection of the driver. For the inflator, the gas which is harmless to the human body has been used.</p>
<p>PASSENGER'S (FRONT) AIR BAG MODULE</p>	 <p>Passenger's (front) air bag module</p> <p>Squib connector</p> <p>Inflator</p>	<p>The passenger's (front) air bag module consists of an air bag, and their fasteners. The air bag is made from nylon and inflates by the gas from the inflator. As a passenger is being pressed to the air bag, it deflates, discharging gas from two vents at the side of the air bag to reduce the shock from the impact. For the inflator, the gas which is harmless to the human body has been used.</p>
<p>SIDE-AIRBAG MODULE</p>	 <p>Side-airbag module</p>	<p>The side-airbag module consists of an air bag, air bag cover, inflator and their fasteners. The modules are installed in the outer side supports of the driver's and front passenger's seatbacks. The side-airbags help protect the occupants regardless of the seat position and seatback angle. The air bags are compactly folded and stored under the cover. On the side of the air bag, there are holes through which gas is partially released to alleviate shock to the occupant when the air bag is deployed. For the inflator, the gas which is harmless to the human body has been used.</p>
<p>CURTAIN AIR BAG MODULE</p>	 <p>Curtain air bag module</p>	<p>The curtain air bag module consists of an air bag, an inflator, and the fixing gear relating to those parts, and is installed in the roof side sections (from the driver's and the passenger's front pillars to the rear pillars). An inflator that does not contain sodium azide is used.</p>

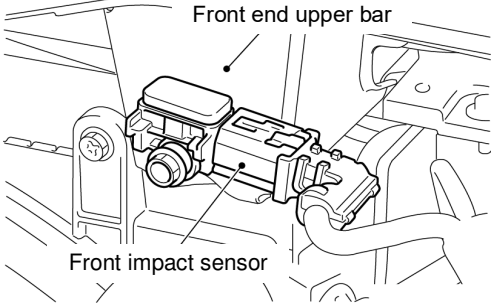
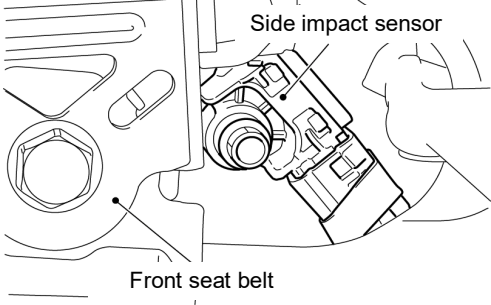
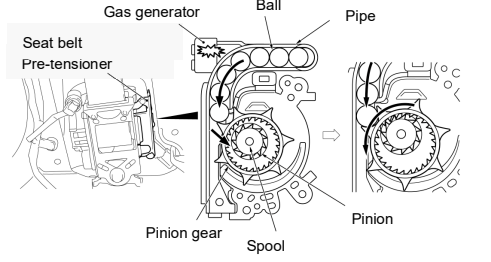
<p>FRONT IMPACT SENSOR</p>	 <p>The diagram shows the front impact sensor installed in the engine room. Labels include 'Front end upper bar' pointing to the upper structure and 'Front impact sensor' pointing to the sensor unit.</p>	<p>The front impact sensor is installed on the headlamp support panel upper in the engine room, and the analogue G-sensor is housed in the front impact sensor.</p> <p>The front impact sensor transmits the coded acceleration data to SRS-ECU. Based on the data, SRS-ECU determines the deployment stage of the front air bag, then energises appropriate squib.</p> <p>SRS-ECU performs the diagnostics of the front impact sensor internal components. If a malfunction occurs, it sets the diagnosis code.</p>
<p>SIDE IMPACT SENSOR</p>	 <p>The diagram shows the side impact sensor installed on the lower part of the centre pillar. Labels include 'Side impact sensor' pointing to the sensor unit and 'Front seat belt' pointing to the seat belt area.</p>	<p>The side impact sensors are installed to the lower part of the centre pillars on both sides, and the analogue G-sensor is housed in the side impact sensor.</p> <p>The front impact sensor transmits the coded acceleration data to SRS-ECU. Based on the data, SRS-ECU determines the deployment of the side-airbags and curtain air bags, then energises appropriate squib(s).</p> <p>SRS-ECU performs the diagnostics of the side impact sensor internal components. If a malfunction occurs, it sets the diagnosis code.</p>
<p>SEAT BELT WITH PRE-TENSIONER</p>	 <p>The diagram illustrates the seat belt pre-tensioner mechanism. Labels include 'Gas generator', 'Ball', 'Pipe', 'Pinion gear', and 'Spool'. It shows the internal components and how they interact to wind the seat belt.</p>	<p>The seat belt incorporating the pretensioner automatically winds the seatbelt upon front impact to reduce forward shifting of the passenger.</p> <p>The seat belt pre-tensioner ignites the gas generator and emits gas with the electric current supplied from SRS-ECU. The gas pressure shifts the ball in the pipe and the balls comes in contact with the protrusion of the ring gear, which is inserted in the ring gear and then interlocked with the pinion is inserted in the ring gear The ring gear rotation forces the pinion to turn the spool toward the belt wind direction to wind the belt.</p>

2. High voltage component location

Construction diagram

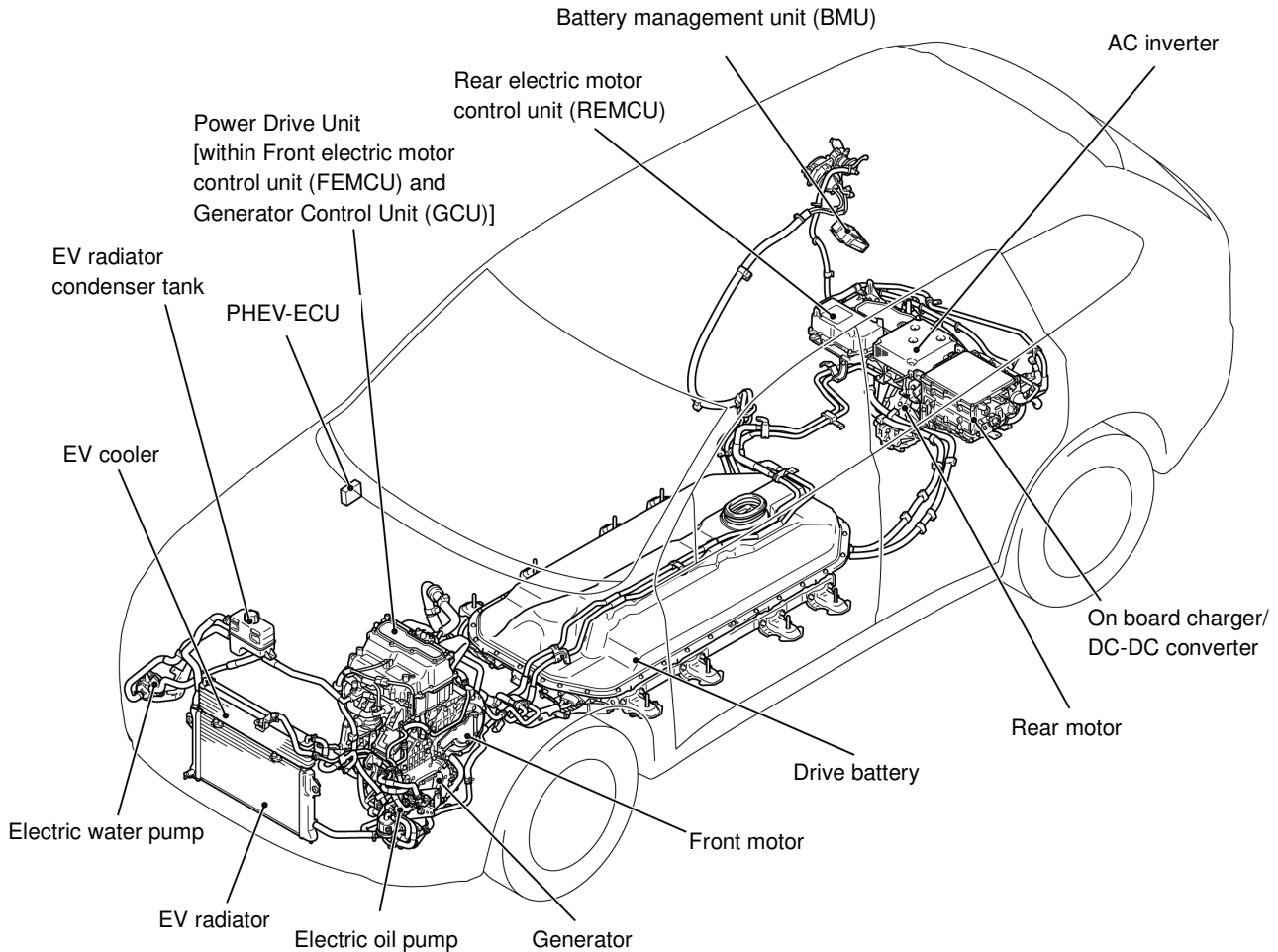

System Operation

<p>DRIVE BATTERY</p>		<p>The drive battery consists of lithium ion battery that is small and lightweight and also has a high energy density. The motor (electric motor unit) and the air conditioner system are powered by the drive battery. The drive battery is housed in the metal case that has high water-resistant properties, vibration-resistant properties, dust-resistant properties and high heat-resistant properties. The case is placed under the floor. The battery has 10 of 8-cell modules in which 8 battery cells are in series. In total, the 80 battery cells are connected in series. The battery generates a high-voltage of 300 V (nominal value). The maximum operating voltage 336 V may be generated depending on the remaining capacity of the battery.</p>
----------------------	--	--------------------------------------------------------------------------------------------------------------------------------------------------------------------------------------------------------------------------------------------------------------------------------------------------------------------------------------------------------------------------------------------------------------------------------------------------------------------------------------------------------------------------------------------------------------------------------------------------------------------------------------------------------------------------------------------------------------------------------------------------------------------

<Characteristics>

- The drive battery, which is based on lithium ion battery, can be charged before the stored energy is used up.
- The drive battery performance gradually decreases due to the duration of use or due to the use conditions.
- The drive battery performance can be varied with ambient temperature. Especially in the lower temperature, the cruising range may become shorter and the required time for charging may also become longer.

- When the vehicle is stored at the extremely high temperature or extremely low temperature, the battery performance can decrease.
- Even if the vehicle is not in use, the drive battery may be gradually discharged and the energy stored in the drive battery will be reduced.

<Precautions in use>

- If the vehicle is not used for a long time, check the drive battery meter reading every three months. If the reading is zero, charge the battery until the reading is shown. Or put the electric motor switch in the READY to automatically start the engine. Wait until the engine stops. Then, turn off the electric motor switch.
- The drive battery is retrieved. When the vehicle is discarded, always contact Mitsubishi Motors Dealer.

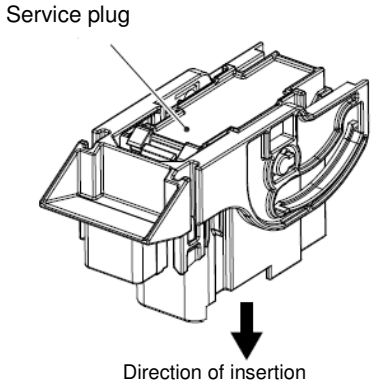
<p>SERVICE PLUG</p>	 <p>Service plug</p> <p>Direction of insertion</p>	<p>The service plug is installed to the lower place of the rear centre passenger seat. Remove the service plug before performing the check and the maintenance work on the high voltage components to ensure the job safety, shutting off the high voltage circuit. Inserting and pulling the service plug switch installed to the drive battery turns ON/OFF the service plug lever.</p> <p>The service plug switch is integrated in the service plug.</p>
---------------------	-------------------------------------------------------------------------------------------------------------------------------------	-------------------------------------------------------------------------------------------------------------------------------------------------------------------------------------------------------------------------------------------------------------------------------------------------------------------------------------------------------------------------------------------------------------------------------------------------------------

3. Discharge measures for drive battery

If the drive battery is damaged or the vehicle is submerged, perform discharge measures as follows.



WARNING;

- Failure to follow these instructions may result in serious injury such as electric shock.
- If electrolyte leaks from the drive battery, or if water gets inside the drive battery, rapid electrolysis may generate hydrogen gas and ignite.
- If water gets inside the drive battery, vigorously inject water (water that does not contain salt water such as tap water, well water, pond water, seawater etc.) and perform discharge treatment.
- Vehicles injected with water should be stored outdoors in a well ventilated area. Open the windows or doors as there is a risk of hydrogen gas filling the vehicle compartment.
- It takes about 84 hours (3.5days) to complete the discharge procedure. Please note that it may cause smoke and fire due to hydrogen gas.
- Since the injected water is converted to an aqueous solution containing metals such as P (Phosphorus) and Li (Lithium), please dispose of it properly as an industrial waste according to local regulations when.

How to discharge measures by in pool

If the drive battery is severely damaged, it is necessary to discharge the drive battery to avoid electric shock and fire.

Perform the discharge measures procedure according to the following procedure.

- 1) Set up an easy set pool in the size of approximately.
550 cm x 250 cm x 100 cm (length x width x height)
- 2) If there is a risk of water leakage from the easy set pool, place a thick plastic sheet under the pool.
- 3) Use a forklift or similar equipment to place the vehicle in the centre of the pool.



CAUTION;

- Place the vehicle horizontally or slightly tilted forward. If you fail to do this, the vehicle may not be submerged up to the required level.
- The negative terminal disconnect for the 12V auxiliary battery should be 1 minutes later the power supply mode of the power switch is turned off.
- Do not remove the service plug for 5 minutes later disconnecting the 12V auxiliary battery negative terminal.



- 4) Turn off the Power switch by pressing it. Remove the 12V auxiliary battery negative terminal.
- 5) Remove the service lid cover in the footwell under the middle of the second seat. (four clips)
- 6) Use an open end wrench (10mm) to remove the service lid. (four nuts)





WARNING;

Always wear Personal Protective Equipment (PPE) when pulling out the service plug.



- 7) Wear Personal Protective Equipment (PPE) and remove the service plug.
 1. Release the lock lever on the service plug.
 2. Raise the service plug lever.
 3. Remove the service plug by pulling it upward.

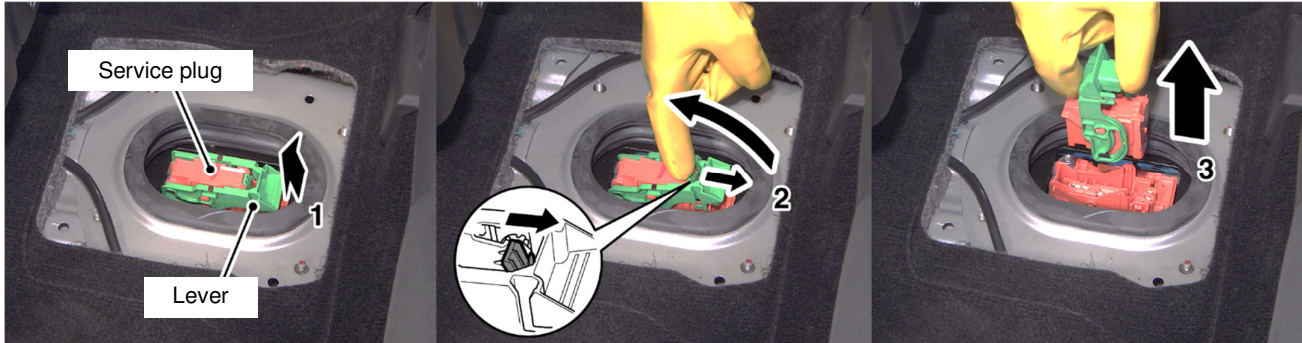

- 8) Open the windows or doors.
- 9) Make sure to use water not containing salt, such as tap water, well water or pond water, to prevent harmful reactions.

Keep pouring a sufficient volume of water, such as from a fire hydrant or a tap. DO NOT attempt to extinguish the fire with a small amount of water. If a small amount of water contacts the inner portion of the Main drive lithium-ion battery, a short circuit can occur causing the release of toxic gas.

Required water level: Keep pouring water until the entire floor is submerged (a minimum required depth of 50 cm is achieved; see illustration below).

This water level is considered deep enough for the main drive lithium-ion battery to be completely submerged in water.

Maintain this water level for at least 84 hours (3.5 days) with the drive battery submerged in water. Check the water level periodically. When the water level is lower than the specified level, add fresh water.

Reference) Water filling amount in the easy set pool.



Until the entire floor is submerged.

(Until the service plug is submerged completely)

How to discharge measures by water injection



CAUTION;

- The negative terminal disconnect for the 12V auxiliary battery should be 1 minutes later the power supply mode of the power switch is turned off.
- Do not remove the service plug for 5 minutes later disconnecting the 12V auxiliary battery negative terminal.



- 1) Move the vehicle to an outside well-ventilated area.
- 2) Turn off the Power switch by pressing it. Remove the 12V auxiliary battery negative terminal.
- 3) Remove the service lid cover in the footwell under the middle of the second seat. (Four clips)
- 4) Use an open end wrench (10mm) to remove the service lid. (four nuts)



WARNING;

Always wear Personal Protective Equipment (PPE) when pulling out the service plug.



- 5) Wear Personal Protective Equipment (PPE) and remove the service plug.
 1. Release the lock lever on the service plug.
 2. Raise the service plug lever.
 3. Remove the service plug by pulling it upward.

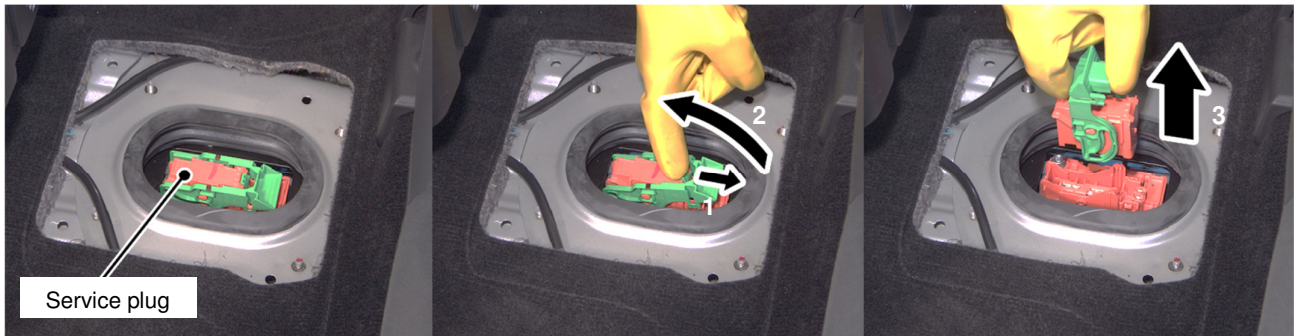

- 6) Place a recovery tray of the injected water under the vehicle.

- 7) Fill with water that does not contain salt, such as tap water, well water or pond water through the opening on the service lid until it is fully.
- 8) When the inside of the drive battery is full, adjust the amount of water so that the fully state can be maintained, and continue flowing for 30 minutes to discharge impurities inside.

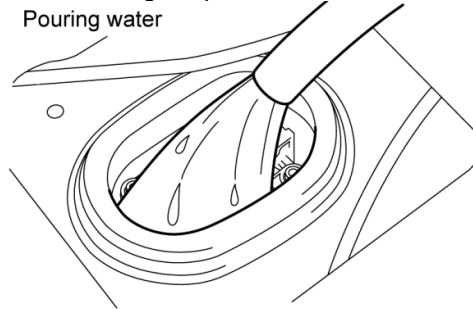

Use a suitable tray to collect the poured water through the drain plug at the bottom of the drive battery.
 (You cannot see the drain plug because it is covered with the battery protector as shown)

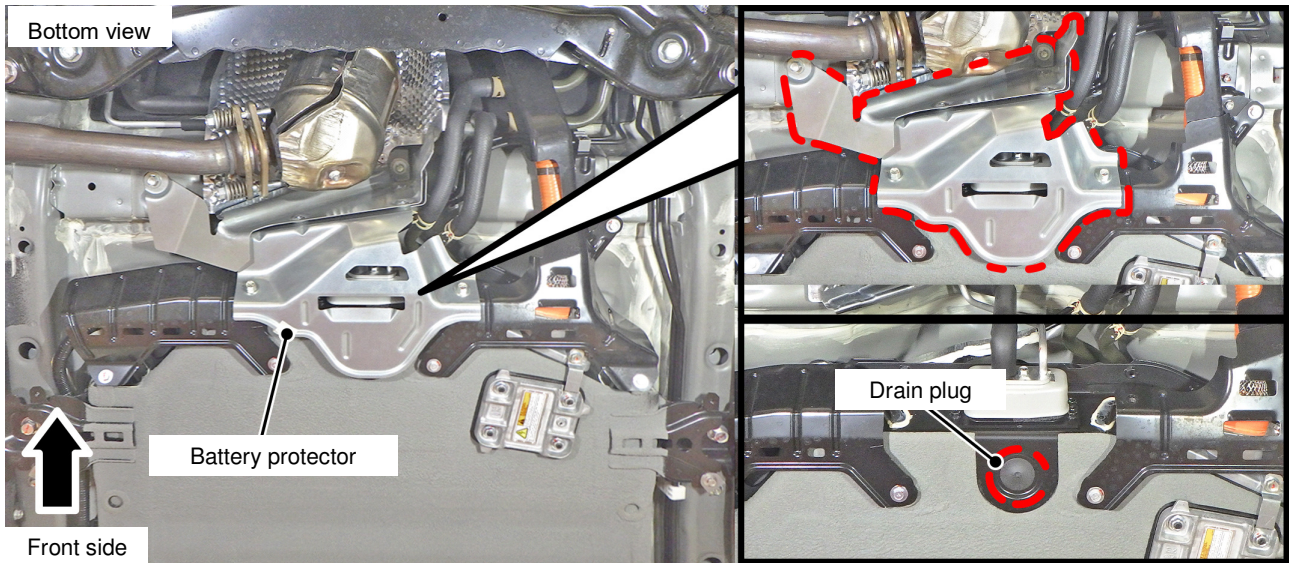

⚠ CAUTION;
 The main drive lithium-ion battery must be properly disposed of as industrial waste according to local regulations.

- 9) Wait for approx. 20 minutes until the water has drained completely.
- 10) Raise the vehicle and then use a 12mm wrench to remove the battery protector.

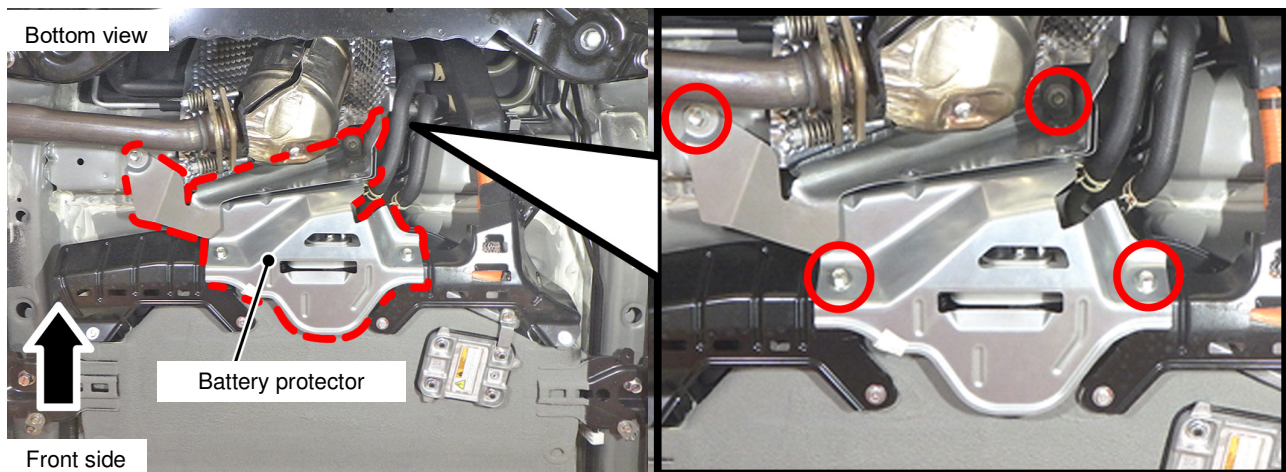

- 11) Place the drain plug gasket (MB992947) and the drain plug cover (MB992946) in that order on the bottom of the drain plug. Then hold them against the bottom of the battery using a jack

MB992946
Drain plug cover



MB992947
Drain plug gasket

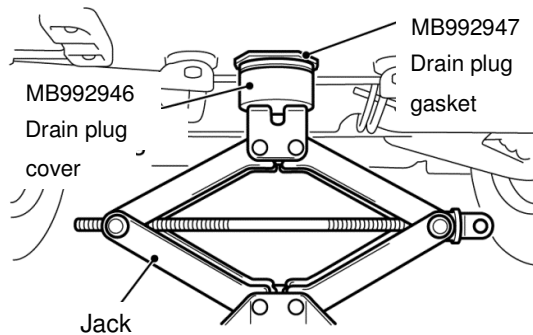
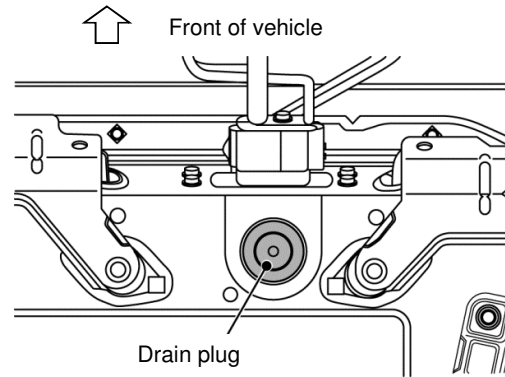
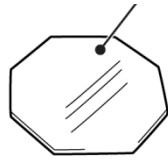

Reference) · MB992947: Drain plug gasket

(Silicone rubber sheet: approx. 70 x 70 x 3 mm) (2.75" x 2.75" x 1.25").

· MB992946: Drain plug cover (Base for the silicone rubber sheet)

* [Drain plug gasket \(MB992947\) and Drain plug cover \(MB992946\) is Mitsubishi Motors special tools](#)

- 12) Fill with water that does not contain salt, such as tap water, well water or pond water through the plug opening under the service lid into the main drive lithium-ion battery until the water overflows.
- 13) Keep the drive battery filled with water for at least 84 hours (3.5 days). Electrolysis of water produces hydrogen inside the battery for that period. Keep the vehicle in an outside well-ventilated area with all windows or doors and tailgate open.

How to drain the water

On the following to collect the water.

Remove the special tools on the underside of the drain plug, and wait until drainage from the drain plug is completed.

When draining water, set the tray under the drain plug and collect the drained water.

Pool	Wait for at least approx. 84 hours (3.5 days), and then drain water from the pool.
Water Injection	Remove the special tools from the bottom of the drain plug, and wait until the water has drained completely. Place a suitable tray under the drain plug to collect the drained water.

How to drain the remaining water

- 1) Use an open end wrench (12mm) to remove the service hole lids on the bottom of the main drive lithium-ion battery and drain the main drive lithium-ion battery.

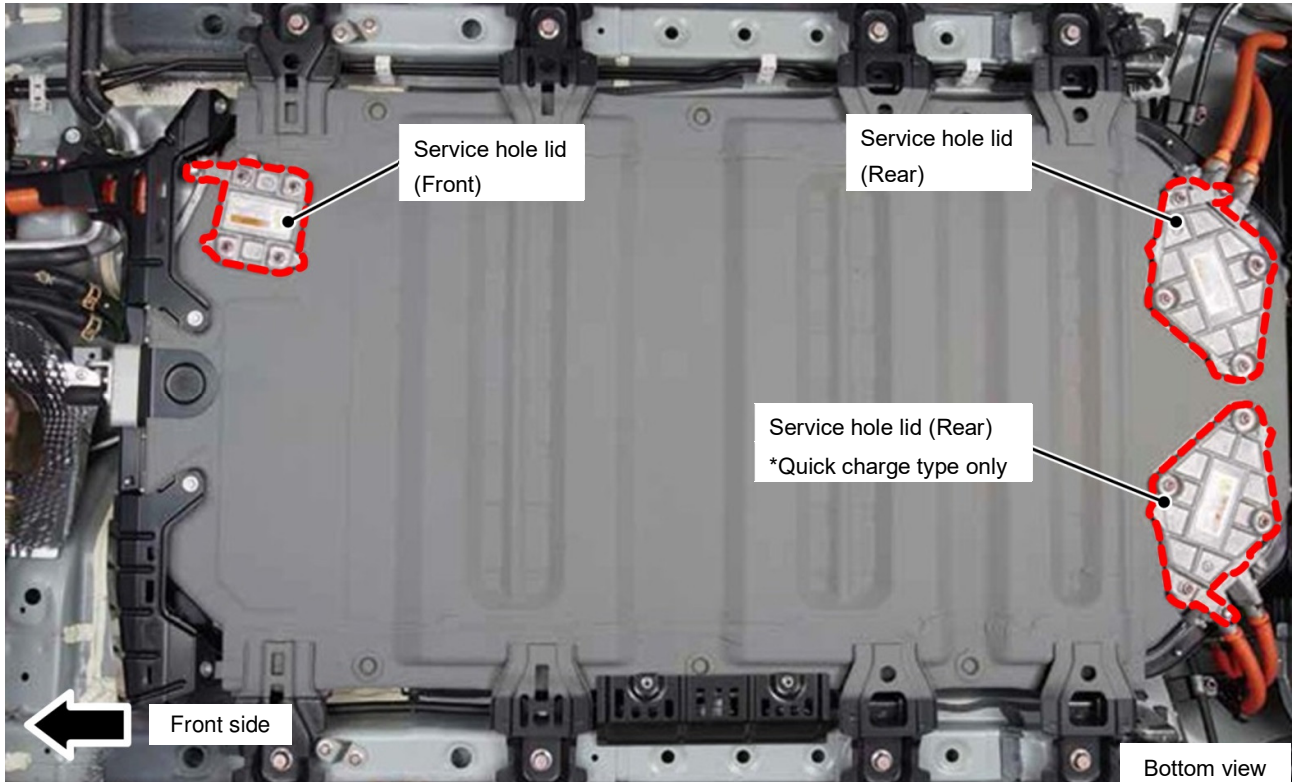

- 2) Remove the ground bracket.
- 3) Remove the service hole lid.

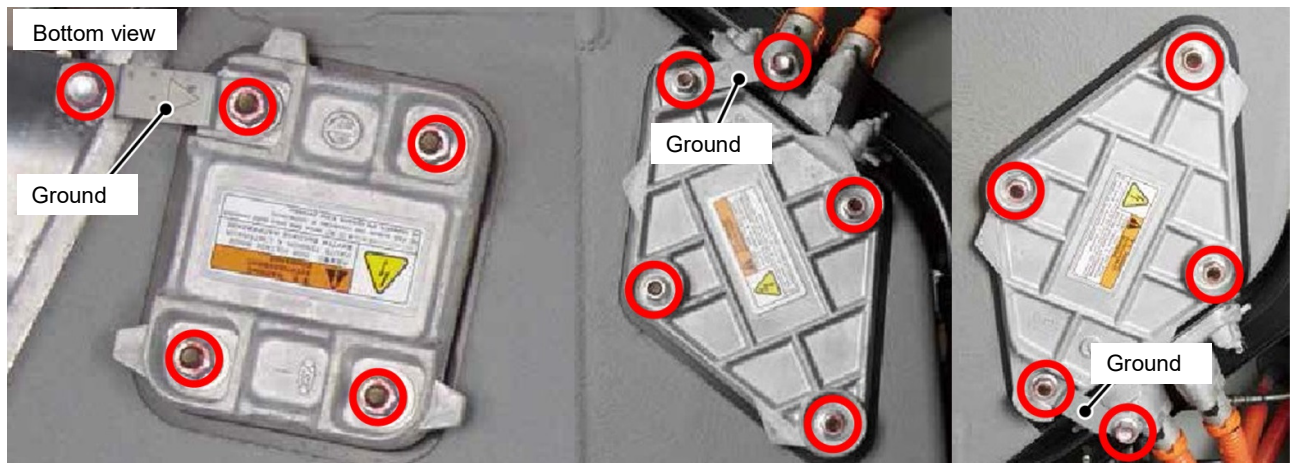

⚠ CAUTION;
The water drained from the drive battery shall be properly disposed of as an industrial waste according to local regulations.







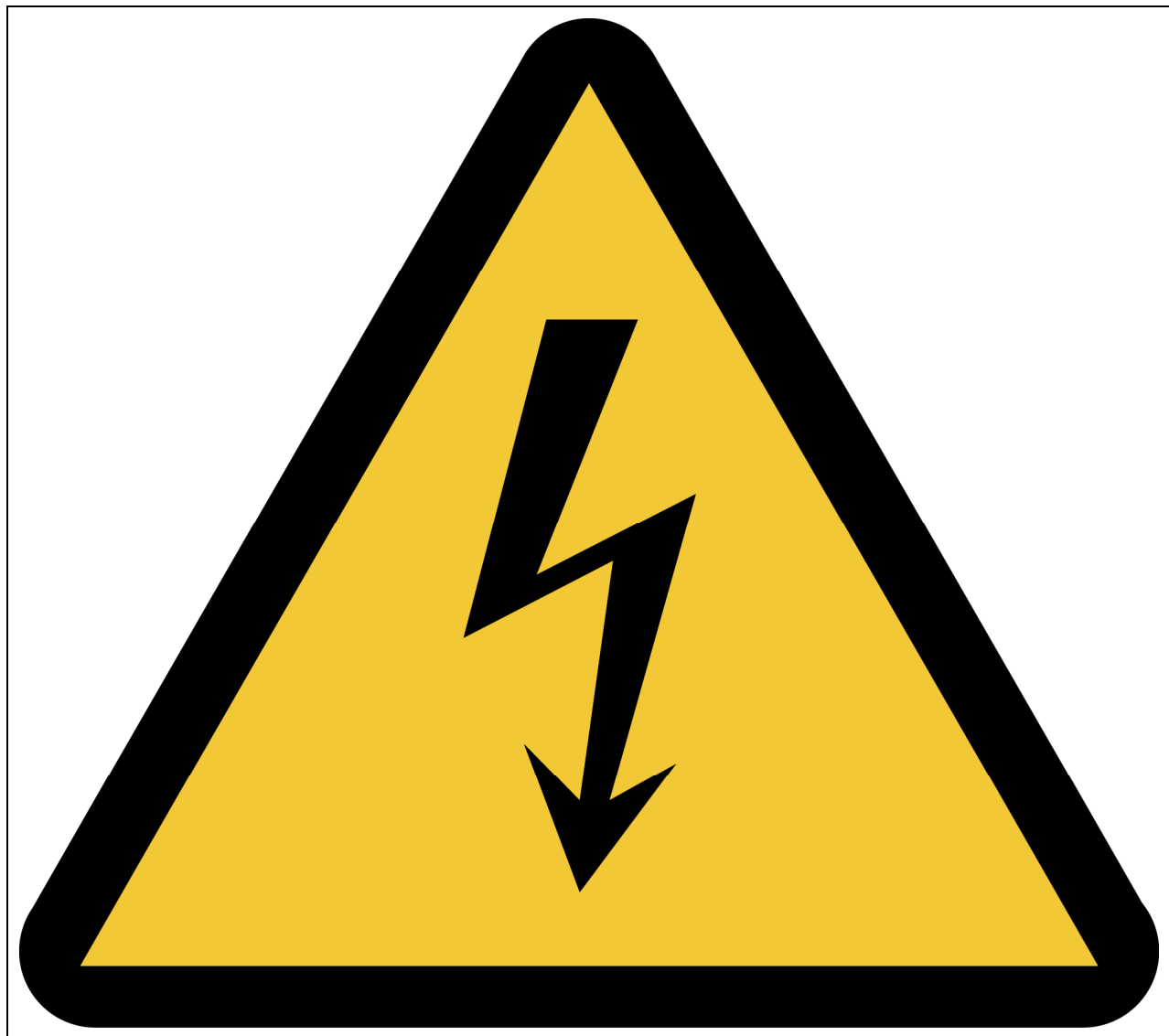



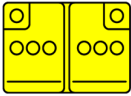

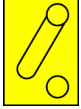

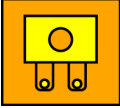









**HIGH VOLTAGE WORK
IN PROGRESS!!
DANGER! DO NOT TOUCH!**

**HIGH VOLTAGE WORK
IN PROGRESS!!
DANGER! DO NOT TOUCH!**

*Before any high voltage work commences, place this signboard on the roof of vehicle after folding on the dotted line.



It is recommended that a warning sign (example provided above) is fixed to or on the vehicle during any emergency work on the vehicle. A sign that complies with local regulation should be used.

10. Explanation of pictograms used					
	12V auxiliary battery		SRS unit		Keyless operation key distance
	Power switch		Airbag inflator		Warning, Electricity
	Fuse box disabling high voltage		Air bag		Seat belt pretensioner
	High voltage cable		Adjustment seat forward or backward		Warning, low temperature
	High voltage component		Adjustment seat height		Air-conditioning component
	Service plug		Steering wheel height adjustment		Lifting point
	Open Hood		Open Tailgate		Fuel tank
	Use ABC powder to extinguish the fire		Use water to extinguish the fire		Risk of damaging human health
	Risk of flammability		Risk of an explosion		Risk of corrosive material / substances

